

# Exploded Diagrams

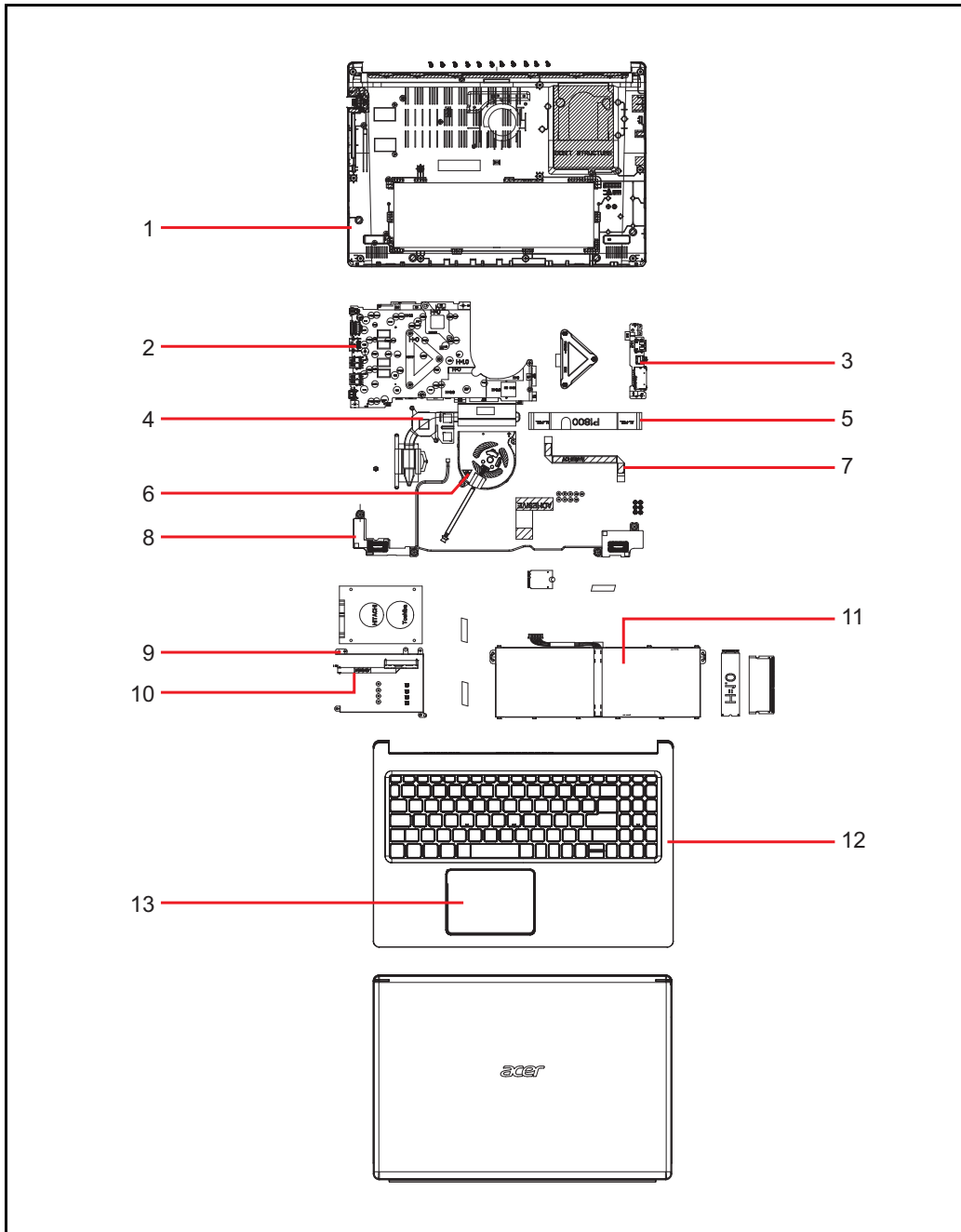

Figure 6-1. System Exploded Diagram

Table 6-1. System Exploded Diagram

No.	Description	Acer Part No.
1	LOWER CASE ASSY BLACK	60.HGLN7.001

**Table 6-1. System Exploded Diagram**

No.	Description	Acer Part No.
2	Mainboard A515-54 Intel i3-8145U 4GB UMA FP BL	NB.HGL11.001
3	USB BOARD	55.HGLN7.001
4	HEAT SINK DIS	24.HGLN7.001
5	FFC CABLE FOR USB BOARD(144.5MM,40P,5V)	50.HGLN7.002
6	FAN DC 5V	23.HGLN7.001
7	FFC CABLE FOR TOUCH PAD(145.5MM,8P,3V)	50.HGLN7.001
8	SPEAKER (W-L/R)	23.HGLN7.002
9	HDD BRACKET	33.HGLN7.001
10	FFC CABLE FOR HDD(12P/17P,5V)	50.HGLN7.003
11	Battery LGC AC14B (5.5mm) Prismatic 4S1P LGC 4 cell 3220mAh Main COMMON w/ LEM+ship mode	KT.0040G.011
12	UPPER CASE ASSY BLACK(Keyboard CHICONY SV5P_A72BWL SV5P Internal 15 Standard 100KS Black Arabic White Backlit power icon 3-numeric,Media key,NK.I1513.0DW)	6B.HDGN7.001
13	TOUCH PAD W/BRACKET/MYLAR BLACK SYC	56.HGLN7.001

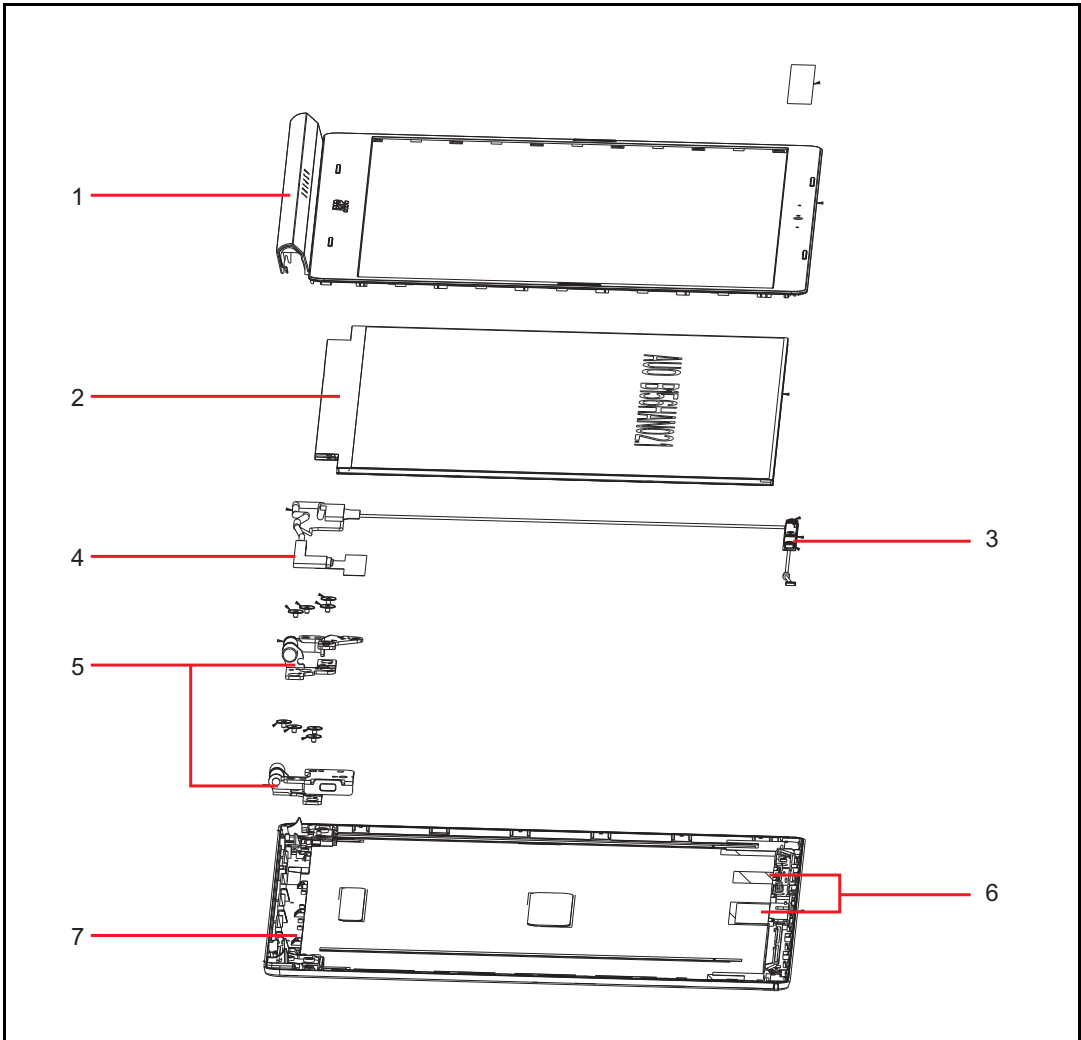

**Figure 6-2. LCD Assembly Exploded Diagram**





**Table 6-2. LCD Assembly Exploded Diagram**

No.	Description	Acer Part No.
1	LCD BEZEL (W/HINGE CAP)GREY	60.HGLN7.003
2	LED LCD Panel CMI 15.6"W WXGA None Glare N156BGA-EA3 LF 220nit 10ms 500:1 (eDP, 3.2mm Max,narrow border)	KL.1560D.034
3	Camera Tech-Front HD Camera TF_OV9728_RTS5838H_AOET_ZTS6031M Unified2 (add Mic*2)	KS.0HD0Q.003
4	LCD CABLE(40/30/6P,19V)	50.HGLN7.005
5	HINGE L	33.HGLN7.002
	HINGE R	33.HGLN7.003
6	ANTENNA (MAIN+AUX,NGFF)	50.HGLN7.004
7	LCD COVER ASSY GREY	60.HGLN7.002







# FRU List

## Aspire A515-54/A515-54G



Table 6-3. FRU List

Category	Description	Acer Part No.
<b>ADAPTER</b>		
	Adapter DELTA 45W 19V 1.1x3.0x7.7 ADP-45FE FD LF Black 45W_3phy	KP.04501.017
	Adapter DELTA 65W 19V 1.1x3.0x7.7 ADP-65DE BA LF Black Meet DOE6, CoC Tier2, IEC 62368	KP.06501.012
	Adapter LITE-ON 65W 19V 1.1x3.0x7.7 PA-1650-50A3 LF BLACK Meet DOE6, CoC Tier2, IEC 62368	KP.06503.018
	Adapter LITE-ON 45W 19V 1.1x3.0x7.7 PA-1450-26A3 LF Black	KP.04503.011
<b>BATTERY</b>		
	Battery LGC AC14B (5.5mm) Prismatic 4S1P LGC 4 cell 3220mAh Main COMMON w/ LEM+ship mode	KT.0040G.011
<b>BOARD</b>		
	Liteon 3rd WiFi 2x2 AC+ BT M.2 QCA NFA344A MU-MIMO	NC.23611.030
	Wireless LAN Intel 802.11ac Bluetooth FM 9560.NGWG.NV JFP2 M.2 2x2AC MU-MIMO/160Mhz + BT5 2230 non-vPro	KE.11A0N.010
	USB BOARD	55.HGLN7.001

**Table 6-3. FRU List (Continued)**

Category	Description	Acer Part No.
	TOUCH PAD W/BRACKET/MYLAR BLACK SYC	56.HGLN7.001
	TOUCH PAD W/BRACKET/MYLAR BLACK EAM	56.HGLN7.002
	TOUCH PAD W/BRACKET/FP BLACK EAM	56.HGJN7.001
	TOUCH PAD W/BRACKET/MYLAR SILVER SYC	56.HGLN7.003
	TOUCH PAD W/BRACKET/MYLAR SILVER EAM	56.HGLN7.004
	TOUCH PAD W/BRACKET/FP SILVER EAM	56.HGJN7.002
	TOUCH PAD W/BRACKET/MYLAR RED SYC	56.HFSN7.001
	TOUCH PAD W/BRACKET/MTLAR RED EAM	56.HFSN7.002
<b>CABLE</b>		
	FFC CABLE FOR FINGER PRINT(121MM,8P,3V)	50.HGJN7.001
	FFC CABLE FOR TOUCH PAD(145.5MM,8P,3V)	50.HGLN7.001
	FFC CABLE FOR USB BOARD(144.5MM,40P,5V)	50.HGLN7.002
	FFC CABLE FOR HDD(12P/17P,5V)	50.HGLN7.003
	ANTENNA (MAIN+AUX,NGFF)	50.HGLN7.004

**Table 6-3. FRU List (Continued)**

Category	Description	Acer Part No.
	LCD CABLE(40/30/6P,19V)	50.HGLN7.005
<b>CAMERA</b>		
	Camera Tech-Front HD Camera TF_OV9728_RTS5838H_AOET_ZTS6031M Unified2 (add Mic*2)	KS.0HD0Q.003
	Camera Tech-Front HD Camera HD Camera TF_OV9734_SP2087L2_AOET_KMM4030 Unified2 (add Mic*2)	KS.0HD0Q.004
	Camera CHICONY HD Camera CH_HM1061_SPA2087_AOET_ZTS6031M Unified2 (add Mic*2)	KS.0HD06.011
	Camera CHICONY HD Camera HD Camera CH_OV9734_RTS5846N_AOET_SPK0493 Unified2 (add Mic*2)	KS.0HD06.012
<b>CASE/COVER/BRACKET</b>		
	UPPER CASE ASSY BLACK(Keyboard CHICONY SV5P_A72BWL SV5P Internal 15 Standard 100KS Black Arabic White Backlit power icon 3-numeric,Media key,NK.I1513.0DW)	6B.HDGN7.001
	UPPER CASE ASSY SILVER(Keyboard CHICONY SV5P_A72BWL SV5P Internal 15 Standard 100KS Black Arabic White Backlit power icon 3-numeric,Media key,NK.I1513.0DW)	6B.HDGN7.002
	UPPER CASE ASSY RED(Keyboard CHICONY SV5P_A72BWL SV5P Internal 15 Standard 100KS Black Arabic White Backlit power icon 3-numeric,Media key,NK.I1513.0DW)	6B.HFTN7.001
	UPPER CASE ASSY BLACK(Keyboard CHICONY SV5P_A72BWL SV5P Internal 15 Standard 101KS Black FR/Arabic White Backlit power icon 3-numeric,Media key,NK.I1513.0EC)	6B.HDGN7.003

**Table 6-3. FRU List (Continued)**

Category	Description	Acer Part No.
	UPPER CASE ASSY SILVER(Keyboard CHICONY SV5P_A72BWL SV5P Internal 15 Standard 101KS Black FR/Arabic White Backlit power icon 3-numeric,Media key,NK.I1513.0EC)	6B.HDGN7.004
	UPPER CASE ASSY RED(Keyboard CHICONY SV5P_A72BWL SV5P Internal 15 Standard 101KS Black FR/Arabic White Backlit power icon 3-numeric,Media key,NK.I1513.0EC)	6B.HFTN7.002
	UPPER CASE ASSY BLACK(Keyboard CHICONY SV5P_A72BWL SV5P Internal 15 Standard 101KS Black Belgium White Backlit power icon 3-numeric,Media key,NK.I1513.0E7)	6B.HDGN7.005
	UPPER CASE ASSY SILVER(Keyboard CHICONY SV5P_A72BWL SV5P Internal 15 Standard 101KS Black Belgium White Backlit power icon 3-numeric,Media key,NK.I1513.0E7)	6B.HDGN7.006
	UPPER CASE ASSY RED(Keyboard CHICONY SV5P_A72BWL SV5P Internal 15 Standard 101KS Black Belgium White Backlit power icon 3-numeric,Media key,NK.I1513.0E7)	6B.HFTN7.003
	UPPER CASE ASSY BLACK(Keyboard CHICONY SV5P_A72BWL SV5P Internal 15 Standard 101KS Black Brazilian Portuguese White Backlit power icon 3-numeric,Media key,NK.I1513.0E8)	6B.HDGN7.007
	UPPER CASE ASSY SILVER(Keyboard CHICONY SV5P_A72BWL SV5P Internal 15 Standard 101KS Black Brazilian Portuguese White Backlit power icon 3-numeric,Media key,NK.I1513.0E8)	6B.HDGN7.008
	UPPER CASE ASSY RED(Keyboard CHICONY SV5P_A72BWL SV5P Internal 15 Standard 101KS Black Brazilian Portuguese White Backlit power icon 3-numeric,Media key,NK.I1513.0E8)	6B.HFTN7.004
	UPPER CASE ASSY BLACK(Keyboard CHICONY SV5P_A72BWL SV5P Internal 15 Standard 100KS Black US International w/ Bulgaria White Backlit power icon 3-numeric,Media key,NK.I1513.0GT)	6B.HDGN7.009
	UPPER CASE ASSY SILVER(Keyboard CHICONY SV5P_A72BWL SV5P Internal 15 Standard 100KS Black US International w/ Bulgaria White Backlit power icon 3-numeric,Media key,NK.I1513.0GT)	6B.HDGN7.010

**Table 6-3. FRU List (Continued)**

Category	Description	Acer Part No.
	UPPER CASE ASSY RED(Keyboard CHICONY SV5P_A72BWL SV5P Internal 15 Standard 100KS Black US International w/ Bulgaria White Backlit power icon 3-numeric,Media key,NK.I1513.0GT)	6B.HFTN7.005
	UPPER CASE ASSY BLACK(Keyboard CHICONY SV5P_A72BWL SV5P Internal 15 Standard 100KS Black US International w/ Canadian French White Backlit power icon 3-numeric,Media key,NK.I1513.0GS)	6B.HDGN7.011
	UPPER CASE ASSY SILVER(Keyboard CHICONY SV5P_A72BWL SV5P Internal 15 Standard 100KS Black US International w/ Canadian French White Backlit power icon 3-numeric,Media key,NK.I1513.0GS)	6B.HDGN7.012
	UPPER CASE ASSY RED(Keyboard CHICONY SV5P_A72BWL SV5P Internal 15 Standard 100KS Black US International w/ Canadian French White Backlit power icon 3-numeric,Media key,NK.I1513.0GS)	6B.HFTN7.006
	UPPER CASE ASSY BLACK(Keyboard CHICONY SV5P_A72BWL SV5P Internal 15 Standard 101KS Black SLO/CRO White Backlit power icon 3-numeric,Media key,NK.I1513.0EL)	6B.HDGN7.013
	UPPER CASE ASSY SILVER(Keyboard CHICONY SV5P_A72BWL SV5P Internal 15 Standard 101KS Black SLO/CRO White Backlit power icon 3-numeric,Media key,NK.I1513.0EL)	6B.HDGN7.014
	UPPER CASE ASSY RED(Keyboard CHICONY SV5P_A72BWL SV5P Internal 15 Standard 101KS Black SLO/CRO White Backlit power icon 3-numeric,Media key,NK.I1513.0EL)	6B.HFTN7.007
	UPPER CASE ASSY BLACK(Keyboard CHICONY SV5P_A72BWL SV5P Internal 15 Standard 101KS Black CZ/SK White Backlit power icon 3-numeric,Media key,NK.I1513.0EA)	6B.HDGN7.015
	UPPER CASE ASSY SILVER(Keyboard CHICONY SV5P_A72BWL SV5P Internal 15 Standard 101KS Black CZ/SK White Backlit power icon 3-numeric,Media key,NK.I1513.0EA)	6B.HDGN7.016
	UPPER CASE ASSY RED(Keyboard CHICONY SV5P_A72BWL SV5P Internal 15 Standard 101KS Black CZ/SK White Backlit power icon 3-numeric,Media key,NK.I1513.0EA)	6B.HFTN7.008



**Table 6-3. FRU List (Continued)**

Category	Description	Acer Part No.
	UPPER CASE ASSY BLACK(Keyboard CHICONY SV5P_A72BWL SV5P Internal 15 Standard 101KS Black Danish White Backlit power icon 3-numeric,Media key,NK.I1513.0EB)	6B.HDGN7.017
	UPPER CASE ASSY SILVER(Keyboard CHICONY SV5P_A72BWL SV5P Internal 15 Standard 101KS Black Danish White Backlit power icon 3-numeric,Media key,NK.I1513.0EB)	6B.HDGN7.018
	UPPER CASE ASSY RED(Keyboard CHICONY SV5P_A72BWL SV5P Internal 15 Standard 101KS Black Danish White Backlit power icon 3-numeric,Media key,NK.I1513.0EB)	6B.HFTN7.009
	UPPER CASE ASSY BLACK(Keyboard CHICONY SV5P_A72BWL SV5P Internal 15 Standard 101KS Black French White Backlit power icon 3-numeric,Media key,NK.I1513.0ED)	6B.HDGN7.019
	UPPER CASE ASSY SILVER(Keyboard CHICONY SV5P_A72BWL SV5P Internal 15 Standard 101KS Black French White Backlit power icon 3-numeric,Media key,NK.I1513.0ED)	6B.HDGN7.020
	UPPER CASE ASSY RED(Keyboard CHICONY SV5P_A72BWL SV5P Internal 15 Standard 101KS Black French White Backlit power icon 3-numeric,Media key,NK.I1513.0ED)	6B.HFTN7.010
	UPPER CASE ASSY BLACK(Keyboard CHICONY SV5P_A72BWL SV5P Internal 15 Standard 101KS Black German White Backlit power icon 3-numeric,Media key,NK.I1513.0EE)	6B.HDGN7.021
	UPPER CASE ASSY SILVER(Keyboard CHICONY SV5P_A72BWL SV5P Internal 15 Standard 101KS Black German White Backlit power icon 3-numeric,Media key,NK.I1513.0EE)	6B.HDGN7.022
	UPPER CASE ASSY RED(Keyboard CHICONY SV5P_A72BWL SV5P Internal 15 Standard 101KS Black German White Backlit power icon 3-numeric,Media key,NK.I1513.0EE)	6B.HFTN7.011
	UPPER CASE ASSY BLACK(Keyboard CHICONY SV5P_A72BWL SV5P Internal 15 Standard 100KS Black Greek White Backlit power icon 3-numeric,Media key,NK.I1513.0DY)	6B.HDGN7.023
UPPER CASE ASSY SILVER(Keyboard CHICONY SV5P_A72BWL SV5P Internal 15 Standard 100KS Black Greek White Backlit power icon 3-numeric,Media key,NK.I1513.0DY)	6B.HDGN7.024	

**Table 6-3. FRU List (Continued)**

Category	Description	Acer Part No.
	UPPER CASE ASSY RED(Keyboard CHICONY SV5P_A72BWL SV5P Internal 15 Standard 100KS Black Greek White Backlit power icon 3-numeric,Media key,NK.I1513.0DY)	6B.HFTN7.012
	UPPER CASE ASSY BLACK(Keyboard CHICONY SV5P_A72BWL SV5P Internal 15 Standard 100KS Black US International w/ Hebrew White Backlit power icon 3-numeric,Media key,NK.I1513.0E5)	6B.HDGN7.025
	UPPER CASE ASSY SILVER(Keyboard CHICONY SV5P_A72BWL SV5P Internal 15 Standard 100KS Black US International w/ Hebrew White Backlit power icon 3-numeric,Media key,NK.I1513.0E5)	6B.HDGN7.026
	UPPER CASE ASSY RED(Keyboard CHICONY SV5P_A72BWL SV5P Internal 15 Standard 100KS Black US International w/ Hebrew White Backlit power icon 3-numeric,Media key,NK.I1513.0E5)	6B.HFTN7.013
	UPPER CASE ASSY BLACK(Keyboard CHICONY SV5P_A72BWL SV5P Internal 15 Standard 101KS Black Hungarian White Backlit power icon 3-numeric,Media key,NK.I1513.0EF)	6B.HDGN7.027
	UPPER CASE ASSY SILVER(Keyboard CHICONY SV5P_A72BWL SV5P Internal 15 Standard 101KS Black Hungarian White Backlit power icon 3-numeric,Media key,NK.I1513.0EF)	6B.HDGN7.028
	UPPER CASE ASSY RED(Keyboard CHICONY SV5P_A72BWL SV5P Internal 15 Standard 101KS Black Hungarian White Backlit power icon 3-numeric,Media key,NK.I1513.0EF)	6B.HFTN7.014
	UPPER CASE ASSY BLACK(Keyboard CHICONY SV5P_A72BWL SV5P Internal 15 Standard 100KS Black Persian White Backlit power icon 3-numeric,Media key,NK.I1513.0E2)	6B.HDGN7.029
	UPPER CASE ASSY SILVER(Keyboard CHICONY SV5P_A72BWL SV5P Internal 15 Standard 100KS Black Persian White Backlit power icon 3-numeric,Media key,NK.I1513.0E2)	6B.HDGN7.030
	UPPER CASE ASSY RED(Keyboard CHICONY SV5P_A72BWL SV5P Internal 15 Standard 100KS Black Persian White Backlit power icon 3-numeric,Media key,NK.I1513.0E2)	6B.HFTN7.015

**Table 6-3. FRU List (Continued)**

Category	Description	Acer Part No.
	UPPER CASE ASSY BLACK(Keyboard CHICONY SV5P_A72BWL SV5P Internal 15 Standard 101KS Black Italian White Backlit power icon 3-numeric,Media key,NK.I1513.0EG)	6B.HDGN7.031
	UPPER CASE ASSY SILVER(Keyboard CHICONY SV5P_A72BWL SV5P Internal 15 Standard 101KS Black Italian White Backlit power icon 3-numeric,Media key,NK.I1513.0EG)	6B.HDGN7.032
	UPPER CASE ASSY RED(Keyboard CHICONY SV5P_A72BWL SV5P Internal 15 Standard 101KS Black Italian White Backlit power icon 3-numeric,Media key,NK.I1513.0EG)	6B.HFTN7.016
	UPPER CASE ASSY BLACK(Keyboard CHICONY SV5P_A72BWL SV5P Internal 15 Standard 104KS Black Japanese White Backlit power icon 3-numeric,Media key,NK.I1513.0ET)	6B.HDGN7.033
	UPPER CASE ASSY SILVER(Keyboard CHICONY SV5P_A72BWL SV5P Internal 15 Standard 104KS Black Japanese White Backlit power icon 3-numeric,Media key,NK.I1513.0ET)	6B.HDGN7.034
	UPPER CASE ASSY RED(Keyboard CHICONY SV5P_A72BWL SV5P Internal 15 Standard 104KS Black Japanese White Backlit power icon 3-numeric,Media key,NK.I1513.0ET)	6B.HFTN7.017
	UPPER CASE ASSY BLACK(Keyboard CHICONY SV5P_A72BWL SV5P Internal 15 Standard 100KS Black Korean White Backlit power icon 3-numeric,Media key,NK.I1513.0DZ)	6B.HDGN7.035
	UPPER CASE ASSY SILVER(Keyboard CHICONY SV5P_A72BWL SV5P Internal 15 Standard 100KS Black Korean White Backlit power icon 3-numeric,Media key,NK.I1513.0DZ)	6B.HDGN7.036
	UPPER CASE ASSY RED(Keyboard CHICONY SV5P_A72BWL SV5P Internal 15 Standard 100KS Black Korean White Backlit power icon 3-numeric,Media key,NK.I1513.0DZ)	6B.HFTN7.018
	UPPER CASE ASSY BLACK(Keyboard CHICONY SV5P_A72BWL SV5P Internal 15 Standard 101KS Black ALA-Spanish White Backlit power icon 3-numeric,Media key,NK.I1513.0E6)	6B.HDGN7.037
UPPER CASE ASSY SILVER(Keyboard CHICONY SV5P_A72BWL SV5P Internal 15 Standard 101KS Black ALA-Spanish White Backlit power icon 3-numeric,Media key,NK.I1513.0E6)	6B.HDGN7.038	

**Table 6-3. FRU List (Continued)**

Category	Description	Acer Part No.
	UPPER CASE ASSY RED(Keyboard CHICONY SV5P_A72BWL SV5P Internal 15 Standard 101KS Black ALA-Spanish White Backlit power icon 3-numeric,Media key,NK.I1513.0E6)	6B.HFTN7.019
	UPPER CASE ASSY BLACK(Keyboard CHICONY SV5P_A72BWL SV5P Internal 15 Standard 101KS Black Norwegian White Backlit power icon 3-numeric,Media key,NK.I1513.0EJ)	6B.HDGN7.039
	UPPER CASE ASSY SILVER(Keyboard CHICONY SV5P_A72BWL SV5P Internal 15 Standard 101KS Black Norwegian White Backlit power icon 3-numeric,Media key,NK.I1513.0EJ)	6B.HDGN7.040
	UPPER CASE ASSY RED(Keyboard CHICONY SV5P_A72BWL SV5P Internal 15 Standard 101KS Black Norwegian White Backlit power icon 3-numeric,Media key,NK.I1513.0EJ)	6B.HFTN7.020
	UPPER CASE ASSY BLACK(Keyboard CHICONY SV5P_A72BWL SV5P Internal 15 Standard 101KS Black Portuguese White Backlit power icon 3-numeric,Media key,NK.I1513.0EK)	6B.HDGN7.041
	UPPER CASE ASSY SILVER(Keyboard CHICONY SV5P_A72BWL SV5P Internal 15 Standard 101KS Black Portuguese White Backlit power icon 3-numeric,Media key,NK.I1513.0EK)	6B.HDGN7.042
	UPPER CASE ASSY RED(Keyboard CHICONY SV5P_A72BWL SV5P Internal 15 Standard 101KS Black Portuguese White Backlit power icon 3-numeric,Media key,NK.I1513.0EK)	6B.HFTN7.021
	UPPER CASE ASSY BLACK(Keyboard CHICONY SV5P_A72BWL SV5P Internal 15 Standard 100KS Black Russian White Backlit power icon 3-numeric,Media key,NK.I1513.0E0)	6B.HDGN7.043
	UPPER CASE ASSY SILVER(Keyboard CHICONY SV5P_A72BWL SV5P Internal 15 Standard 100KS Black Russian White Backlit power icon 3-numeric,Media key,NK.I1513.0E0)	6B.HDGN7.044
	UPPER CASE ASSY RED(Keyboard CHICONY SV5P_A72BWL SV5P Internal 15 Standard 100KS Black Russian White Backlit power icon 3-numeric,Media key,NK.I1513.0E0)	6B.HFTN7.022
UPPER CASE ASSY BLACK(Keyboard CHICONY SV5P_A72BWL SV5P Internal 15 Standard 101KS Black Nordic White Backlit power icon 3-numeric,Media key,NK.I1513.0EH)	6B.HDGN7.045	

**Table 6-3. FRU List (Continued)**

Category	Description	Acer Part No.
	UPPER CASE ASSY SILVER(Keyboard CHICONY SV5P_A72BWL SV5P Internal 15 Standard 101KS Black Nordic White Backlit power icon 3-numeric,Media key,NK.I1513.0EH)	6B.HDGN7.046
	UPPER CASE ASSY RED(Keyboard CHICONY SV5P_A72BWL SV5P Internal 15 Standard 101KS Black Nordic White Backlit power icon 3-numeric,Media key,NK.I1513.0EH)	6B.HFTN7.023
	UPPER CASE ASSY BLACK(Keyboard CHICONY SV5P_A72BWL SV5P Internal 15 Standard 101KS Black Spanish White Backlit power icon 3-numeric,Media key,NK.I1513.0EM)	6B.HDGN7.047
	UPPER CASE ASSY SILVER(Keyboard CHICONY SV5P_A72BWL SV5P Internal 15 Standard 101KS Black Spanish White Backlit power icon 3-numeric,Media key,NK.I1513.0EM)	6B.HDGN7.048
	UPPER CASE ASSY RED(Keyboard CHICONY SV5P_A72BWL SV5P Internal 15 Standard 101KS Black Spanish White Backlit power icon 3-numeric,Media key,NK.I1513.0EM)	6B.HFTN7.024
	UPPER CASE ASSY BLACK(Keyboard CHICONY SV5P_A72BWL SV5P Internal 15 Standard 101KS Black Sweden White Backlit power icon 3-numeric,Media key,NK.I1513.0EN)	6B.HDGN7.049
	UPPER CASE ASSY SILVER(Keyboard CHICONY SV5P_A72BWL SV5P Internal 15 Standard 101KS Black Sweden White Backlit power icon 3-numeric,Media key,NK.I1513.0EN)	6B.HDGN7.050
	UPPER CASE ASSY RED(Keyboard CHICONY SV5P_A72BWL SV5P Internal 15 Standard 101KS Black Sweden White Backlit power icon 3-numeric,Media key,NK.I1513.0EN)	6B.HFTN7.025
	UPPER CASE ASSY BLACK(Keyboard CHICONY SV5P_A72BWL SV5P Internal 15 Standard 101KS Black Swiss/G White Backlit power icon 3-numeric,Media key,NK.I1513.0EP)	6B.HDGN7.051
	UPPER CASE ASSY SILVER(Keyboard CHICONY SV5P_A72BWL SV5P Internal 15 Standard 101KS Black Swiss/G White Backlit power icon 3-numeric,Media key,NK.I1513.0EP)	6B.HDGN7.052
UPPER CASE ASSY RED(Keyboard CHICONY SV5P_A72BWL SV5P Internal 15 Standard 101KS Black Swiss/G White Backlit power icon 3-numeric,Media key,NK.I1513.0EP)	6B.HFTN7.026	

**Table 6-3. FRU List (Continued)**

Category	Description	Acer Part No.
	UPPER CASE ASSY BLACK(Keyboard CHICONY SV5P_A72BWL SV5P Internal 15 Standard 100KS Black Traditional Chinese White Backlit power icon 3-numeric, Media key, NK.I1513.0DX)	6B.HDGN7.053
	UPPER CASE ASSY SILVER(Keyboard CHICONY SV5P_A72BWL SV5P Internal 15 Standard 100KS Black Traditional Chinese White Backlit power icon 3-numeric, Media key, NK.I1513.0DX)	6B.HDGN7.054
	UPPER CASE ASSY RED(Keyboard CHICONY SV5P_A72BWL SV5P Internal 15 Standard 100KS Black Traditional Chinese White Backlit power icon 3-numeric, Media key, NK.I1513.0DX)	6B.HFTN7.027
	UPPER CASE ASSY BLACK(Keyboard CHICONY SV5P_A72BWL SV5P Internal 15 Standard 100KS Black Thailand White Backlit power icon 3-numeric,Media key,NK.I1513.0E3)	6B.HDGN7.055
	UPPER CASE ASSY SILVER(Keyboard CHICONY SV5P_A72BWL SV5P Internal 15 Standard 100KS Black Thailand White Backlit power icon 3-numeric,Media key,NK.I1513.0E3)	6B.HDGN7.056
	UPPER CASE ASSY RED(Keyboard CHICONY SV5P_A72BWL SV5P Internal 15 Standard 100KS Black Thailand White Backlit power icon 3-numeric,Media key,NK.I1513.0E3)	6B.HFTN7.028
	UPPER CASE ASSY BLACK(Keyboard CHICONY SV5P_A72BWL SV5P Internal 15 Standard 101KS Black Turkish White Backlit power icon 3-numeric,Media key,NK.I1513.0EQ)	6B.HDGN7.057
	UPPER CASE ASSY SILVER(Keyboard CHICONY SV5P_A72BWL SV5P Internal 15 Standard 101KS Black Turkish White Backlit power icon 3-numeric,Media key,NK.I1513.0EQ)	6B.HDGN7.058
	UPPER CASE ASSY RED(Keyboard CHICONY SV5P_A72BWL SV5P Internal 15 Standard 101KS Black Turkish White Backlit power icon 3-numeric,Media key,NK.I1513.0EQ)	6B.HFTN7.029
	UPPER CASE ASSY BLACK(Keyboard CHICONY SV5P_A72BWL SV5P Internal 15 Standard 100KS Black US International White Backlit power icon 3-numeric, Media key, NK.I1513.0E4)	6B.HDGN7.059

**Table 6-3. FRU List (Continued)**

Category	Description	Acer Part No.
	UPPER CASE ASSY RED(Keyboard CHICONY SV5T_A72B SV5T Internal 15 Standard 101KS Black UK Black, power icon, 3-numeric, Media key,NK.I1513.0FP,NK.I1515.05U,NK.I1517.0BS)	6B.HFSN7.031
	UPPER CASE ASSY BLACK(Keyboard CHICONY SV5T_A72B SV5T Internal 15 Standard 100KS Black Ukrainian Black, power icon, 3-numeric, Media key, NK.I1513.0EZ, NK.I1515.052, NK.I1517.0B0)	6B.HDEN7.063
	UPPER CASE ASSY SILVER(Keyboard SUNREX SV5T_A72B SV5T Internal 15 Standard 100KS Black Ukrainian Black, power icon, 3-numeric, Media key,NK.I1515.052,NK.I1517.0B0,)	6B.HDEN7.064
	UPPER CASE ASSY RED(Keyboard CHICONY SV5T_A72B SV5T Internal 15 Standard 100KS Black Ukrainian Black, power icon, 3-numeric, Media key, NK.I1513.0EZ, NK.I1515.052, NK.I1517.0B0)	6B.HFSN7.032
	LOWER CASE ASSY BLACK	60.HGLN7.001
	LOWER CASE ASSY SILVER	60.HFQN7.001
	LOWER CASE ASSY RED	60.HFSN7.001
	LCD COVER ASSY GREY	60.HGLN7.002
	LCD COVER ASSY SILVER	60.HFQN7.002
	LCD COVER ASSY RED	60.HFSN7.002
	HDD BRACKET	33.HGLN7.001
	LCD BEZEL (W/HINGE CAP)GREY	60.HGLN7.003
	LCD BEZEL (W/HINGE CAP)SILVER	60.HFQN7.003
	LCD BEZEL (W/HINGE CAP)RED	60.HFSN7.003







**Table 6-3. FRU List (Continued)**





Category	Description	Acer Part No.
	HINGE L	33.HGLN7.002
	HINGE R	33.HGLN7.003
<b>FAN</b>		
	FAN DC 5V	23.HGLN7.001
<b>HARD DISK DRIVE</b>		
	HDD WD 2.5" 5400rpm 1000GB WD10SPZX-21Z10T0 , 7mmzh 1D , 1TB/P , MN1000S SATA III 128MB LF F/W: 02.01A02	KH.01K08.035
	HDD WD 2.5" 5400rpm 2000GB WD20SPZX-21UA7T0 , 7mmzh 2D , 1TB/P , MN1000M SATA III 128MB LF F/W:01.01A01	KH.02K08.020
	HDD TOSHIBA 2.5" 5400rpm 1000GB MQ04ABF100 , 1TB/P, acer code SATA III 128MB LF+HF F/W:JU001J	KH.01K04.016
	Flash Disk KINGSTON SSD NAND 128GB RBU-SNS8154P3/128GJ1 LF+HF	KN.12807.029
	Flash Disk KINGSTON SSD NAND 256GB RBU-SNS8154P3/256GJ1 LF+HF	KN.25607.025
	Flash Disk SANDISK SSD NAND 256GB SDAPNUW-256G-1014 LF+HF	KN.2560D.010
	Flash Disk SANDISK SSD NAND 512GB SDAPNUW-512G-1014 LF+HF	KN.5120D.004
<b>HEATSINK</b>		
	HEAT SINK DIS	24.HGLN7.001
	HEAT SINK UMA	24.HGLN7.002



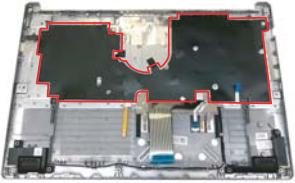

**Table 6-3. FRU List (Continued)**

Category	Description	Acer Part No.
<b>LCD</b>		
	LED LCD Panel CMI 15.6"W WXGA None Glare N156BGA-EA3 LF 220nit 10ms 500:1 (eDP, 3.2mm Max,narrow border)	KL.1560D.034
	LED LCD Panel AUO 15.6"W FHD None Glare B156HAN02.1 LF 250nit 25ms 700:1 (eDP, value IPS, narrow border)	KL.15605.040
	LED LCD Panel AUO 15.6"W FHD None Glare B156HTN06.1 LF 220nit 8ms 400:1 (eDP, narrow border, 3.2mm max, value)	KL.15605.050
<b>MAINBOARD</b>		
 	Mainboard A515-54 Intel i3-8145U 4GB UMA FP BL	NB.HGL11.001
	Mainboard A515-54 Intel i5-8265U 4GB UMA BL	NB.HDJ11.002
	Mainboard A515-54 Intel i5-8265U 4GB UMA FP BL	NB.HGL11.002
	Mainboard A515-54 Intel i7-8565U 4GB UMA FP BL	NB.HGL11.003
	Mainboard A515-54G Intel i5-8265U 4GB N17SG2 2GB BL	NB.HDG11.001
	Mainboard A515-54G Intel i5-8265U 4GB N17SG2 2GB FP BL	NB.HGJ11.002
	Mainboard A515-54G Intel i7-8565U 4GB N17SG2 2GB FP BL	NB.HGJ11.003
<b>MEMORY</b>		
	Memory KINGSTON SO-DIMM DDRIV 2666 4GB ACR26D4S9S1KA-4 LF+HF 512*16 NA-A	KN.4GB07.043
	Memory HYNIX SO-DIMM DDRIV 2666 8GB HMA81GS6CJR8N-VK LF+HF 1024*8 1Xnm, AL	KN.8GB0G.058
	Memory MICRON SO-DIMM DDRIV 3200 16GB MTA16ATF2G64HZ-3G2J1 LF+HF 1024*8 Z21C	KN.16G04.013
	Memory KINGSTON SO-DIMM DDRIV 2666 16GB ACR26D4S9D8ME-16 LF+HF 1024*8	KN.16G07.028

**Table 6-3. FRU List (Continued)**

Category	Description	Acer Part No.
<b>POWER CORD</b>		
	POWER CORD 1M 125V JAP BLACK	27.NE307.001
	POWER CORD 1M 125V ARG BLACK	27.NE307.004
	POWER CORD 1M 125V AUS BLACK	27.NE307.005
	POWER CORD 1M 125V BRAZIL BLACK	27.NE307.006
	POWER CORD 1M 125V CHINA BLACK	27.NE307.007
	POWER CORD 1M 125V DENMARK BLACK	27.NE307.008
	POWER CORD 1M 125V INDIA BLACK	27.NE307.009
	POWER CORD 1M 125V ISRAEL BLACK	27.NE307.010
	POWER CORD 1M 125V ITL BLACK	27.NE307.011
	POWER CORD 1M 125V S.AFRICA BLACK	27.NE307.012
	POWER CORD 1M 125V SWISS BLACK	27.NE307.013
	POWER CORD 1M 125V EUR+KOR BLACK	27.NE307.015
	POWER CORD 1M 125V US BLACK	27.NE307.003
	POWER CORD 1M 125V UK BLACK	27.NE307.014
	POWER CORD 1M 125V TAIWAN BLACK	27.NE307.002
POWER CORD 1M 125V KOR BLACK	27.MVSN7.001	
<b>SPEAKER</b>		
	SPEAKER (W-L/R)	23.HGLN7.002
<b>MISCELLANEOUS</b>		
	LCD ADHESIVE TAPE	47.HGLN7.001
	RUBBER FOR MIC	47.HGLN7.002
	CONDUCTIVE FABRIC	47.HGLN7.003

**Table 6-3. FRU List (Continued)**

Category	Description	Acer Part No.
	INS MYLAR WITH UPPERCASE FOR DIS SKU	47.HGJN7.001
	INS MYLAR WITH UPPERCASE FOR UMA SKU	47.HGKN7.001
	INSULATOR MYLAR FOR MB	47.HGKN7.002





# Screw List

---

## Aspire A515-54/A515-54G

---





Table 6-5. Screw List

CATEGORY	Description	Acer Part No.
	SCREWM2*2.5-I(BNI)(NYLOK)D7T0.3IRON	86.GE8N7.001
	SCREW M2.0*3.0-I(BZN)(NYLOK)IRON	86.GDEN7.001
	SCREWM2.5*1.8-I(NINYLOK)D5T3.7STEEL	86.GDEN7.002
	SCREW M2.5*6-I(BNI)(NYLOK)IRON	86.SHXN7.004
	SCREW M3*0.5+3.5I	86.TDY07.003

## Aspire A515-55

---

Table 6-6. Screw List

CATEGORY	Description	Acer Part No.
	SCREWM2*2.5-I(BNI)(NYLOK)D7T0.3IRON	86.GE8N7.001
	SCREW M2*2.8-IBNI(NYLOK(D5,T0.5STEEL	86.HG6N7.001
	SCREWM2.5*1.8-I(NINYLOK)D5T3.7STEEL	86.GDEN7.002
	SCREW M2.5*6-I(BNI)(NYLOK)IRON	86.SHXN7.004
	SCREW M3*0.5+3.5I	86.TDY07.003