

Exploded Diagrams

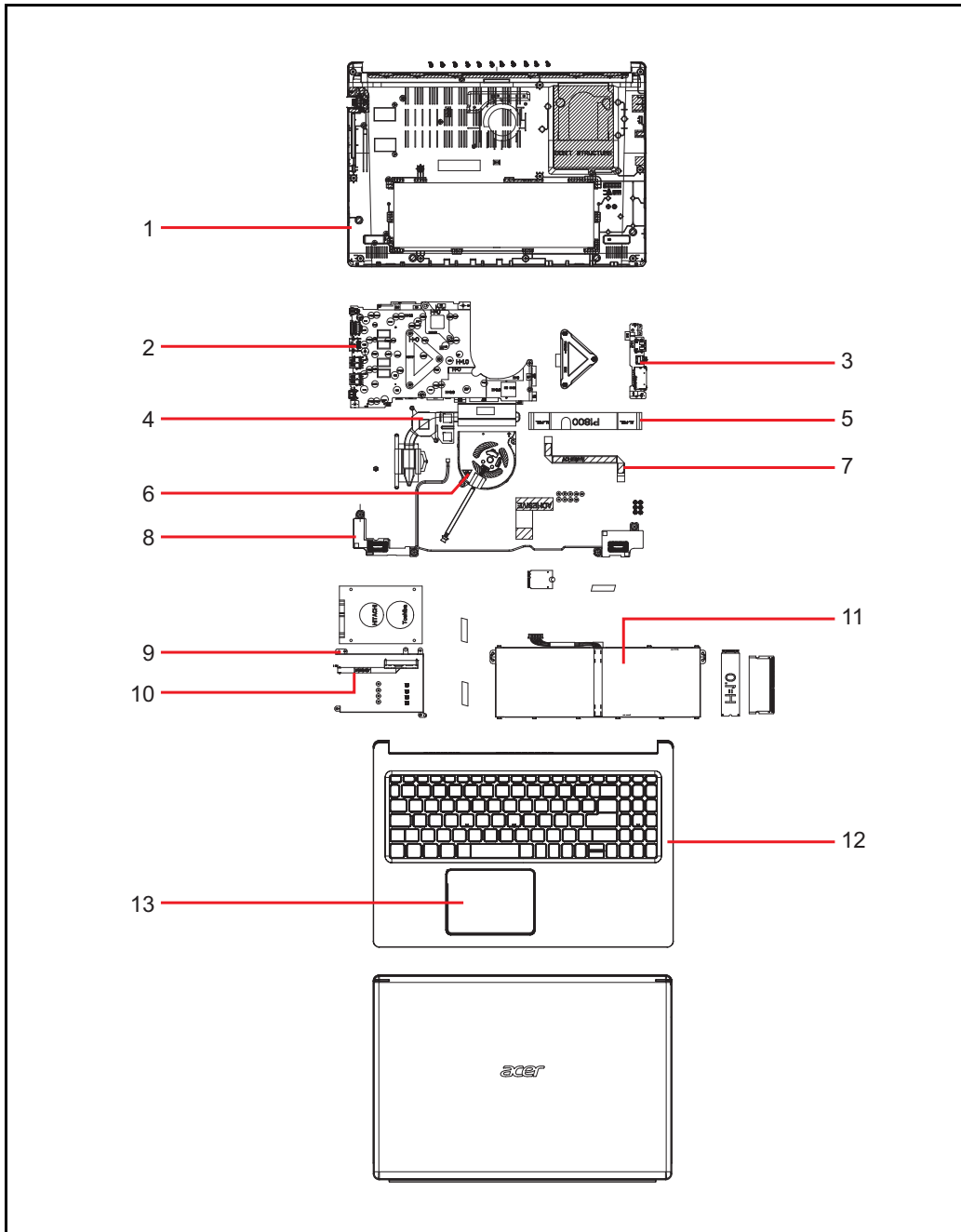

Figure 6-1. System Exploded Diagram

Table 6-1. System Exploded Diagram

No.	Description	Acer Part No.
1	LOWER CASE ASSY BLACK	60.HGLN7.001

Table 6-1. System Exploded Diagram

No.	Description	Acer Part No.
2	Mainboard A515-54 Intel i3-8145U 4GB UMA FP BL	NB.HGL11.001
3	USB BOARD	55.HGLN7.001
4	HEAT SINK DIS	24.HGLN7.001
5	FFC CABLE FOR USB BOARD(144.5MM,40P,5V)	50.HGLN7.002
6	FAN DC 5V	23.HGLN7.001
7	FFC CABLE FOR TOUCH PAD(145.5MM,8P,3V)	50.HGLN7.001
8	SPEAKER (W-L/R)	23.HGLN7.002
9	HDD BRACKET	33.HGLN7.001
10	FFC CABLE FOR HDD(12P/17P,5V)	50.HGLN7.003
11	Battery LGC AC14B (5.5mm) Prismatic 4S1P LGC 4 cell 3220mAh Main COMMON w/ LEM+ship mode	KT.0040G.011
12	UPPER CASE ASSY BLACK(Keyboard CHICONY SV5P_A72BWL SV5P Internal 15 Standard 100KS Black Arabic White Backlit power icon 3-numeric,Media key,NK.I1513.0DW)	6B.HDGN7.001
13	TOUCH PAD W/BRACKET/MYLAR BLACK SYC	56.HGLN7.001

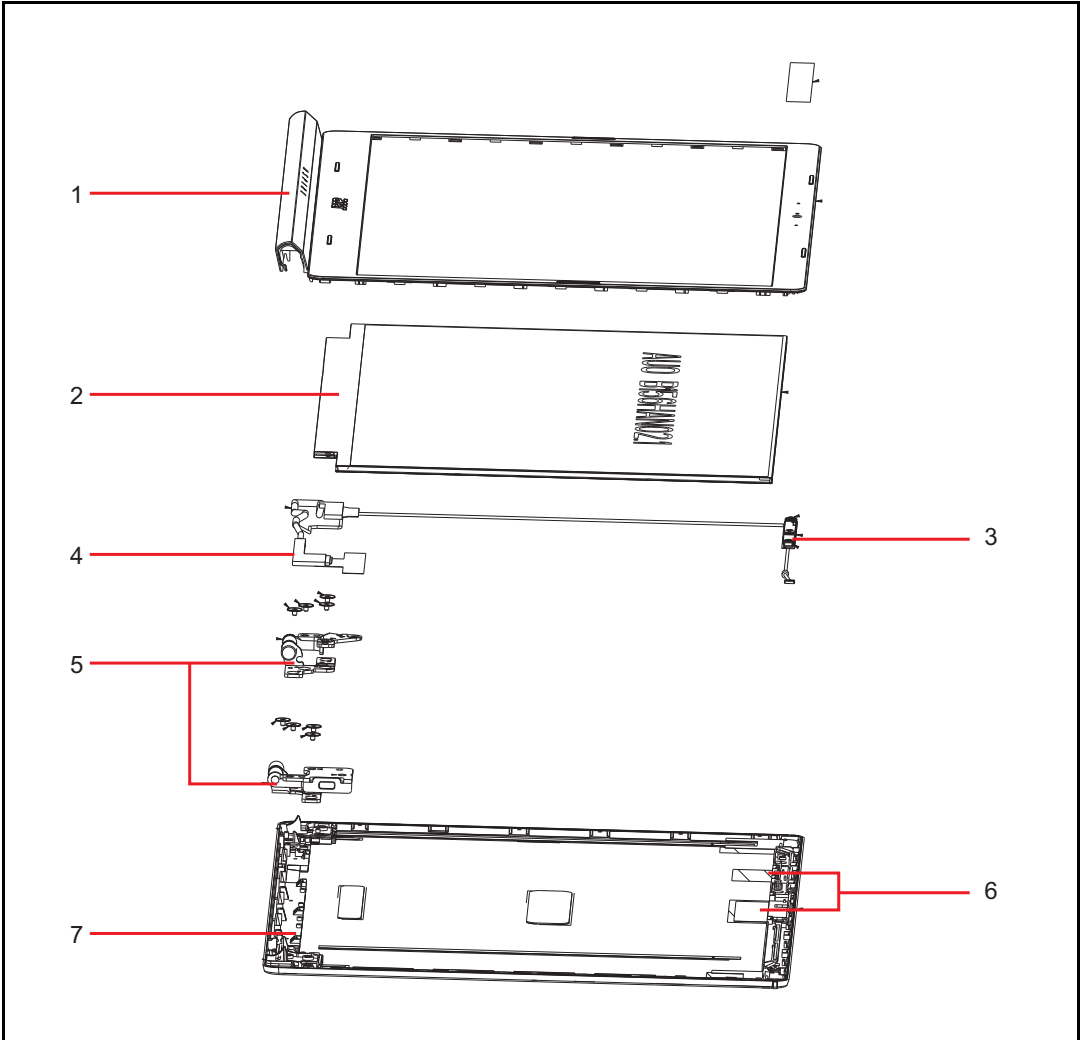

Figure 6-2. LCD Assembly Exploded Diagram

Table 6-2. LCD Assembly Exploded Diagram

No.	Description	Acer Part No.
1	LCD BEZEL (W/HINGE CAP)GREY	60.HGLN7.003
2	LED LCD Panel CMI 15.6"W WXGA None Glare N156BGA-EA3 LF 220nit 10ms 500:1 (eDP, 3.2mm Max,narrow border)	KL.1560D.034
3	Camera Tech-Front HD Camera TF_OV9728_RTS5838H_AOET_ZTS6031M Unified2 (add Mic*2)	KS.0HD0Q.003
4	LCD CABLE(40/30/6P,19V)	50.HGLN7.005
5	HINGE L	33.HGLN7.002
	HINGE R	33.HGLN7.003
6	ANTENNA (MAIN+AUX,NGFF)	50.HGLN7.004
7	LCD COVER ASSY GREY	60.HGLN7.002

Aspire A515-55

Table 6-4. FRU List

Category	Description	Acer Part No.
ADAPTER		
	Adapter DELTA 45W 19V 1.1x3.0x7.7 ADP-45FE FD LF Black 45W_3phy	KP.04501.017
	Adapter LITE-ON 45W 19V 1.1x3.0x7.7 PA-1450-26A3 LF Black	KP.04503.011
	Adapter Chicony Power 45W 19V 1.1x3.0x7.7 Black A045R072P LF Black Meet CoC Tier2 & IEC 62368, No acer logo	KP.0450H.013
	Adapter DELTA 65W 19V 1.1x3.0x7.7 ADP-65DE BA LF Black Meet DOE6, CoC Tier2, IEC 62368	KP.06501.012
	Adapter LITE-ON 65W 19V 1.1x3.0x7.7 PA-1650-50A3 LF BLACK Meet DOE6, CoC Tier2, IEC 62368	KP.06503.018
	Adapter Chicony Power 65W 19V 1.1x3.0x7.7 Yellow A065R178P LF Black Meet IEC62368 & CoC Tier2, no acer logo	KP.0650H.013
BATTERY		
	Battery MURATA Typ.48Wh 4200mAh 3S1P 248x84.4x5.5(mm) AP18C 11.4V 60W Polymer	KT.00304.012
	Battery LGC AP18C Polymer 3S1P LGC 3 cell 4343mAh Main COMMON	KT.0030G.020
BOARD		
	Liteon 3rd WiFi 2x2 AC+ BT M.2 QCA NFA344A MU-MIMO	NC.23611.030
	Wireless LAN Intel 802.11ax Bluetooth FM AX201.NGWG.NV WiFi 6 AX 2x2 HrP2 M.2 + BT 5.0 2230 No vPro	KE.11X0N.006
	USB BOARD	55.HGLN7.001

Table 6-4. FRU List (Continued)

Category	Description	Acer Part No.
	TOUCH PAD W/BRACKET/MYLAR BLACK SYC	56.HGLN7.001
	TOUCH PAD W/BRACKET/MYLAR BLACK EAM	56.HGLN7.002
	TOUCH PAD W/BRACKET/FP BLACK EAM	56.HGJN7.001
	TOUCH PAD W/BRACKET/MYLAR SILVER SYC	56.HGLN7.003
	TOUCH PAD W/BRACKET/MYLAR SILVER EAM	56.HGLN7.004
	TOUCH PAD W/BRACKET/FP SILVER EAM	56.HGJN7.002
	TOUCH PAD W/BRACKET/MYLAR RED SYC	56.HFSN7.001
	TOUCH PAD W/BRACKET/MTLAR RED EAM	56.HFSN7.002
CABLE		
	FFC CABLE FOR FINGER PRINT(121MM,8P,3V)	50.HGJN7.001
	FFC CABLE FOR TOUCH PAD(145.5MM,8P,3V)	50.HGLN7.001
	FFC CABLE FOR USB BOARD(144.5MM,40P,5V)	50.HGLN7.002
	FFC CABLE FOR HDD(12P/17P,5V)	50.HGLN7.003
	ANTENNA (MAIN+AUX,NGFF)	50.HGLN7.004

Table 6-4. FRU List (Continued)



Category	Description	Acer Part No.
	LCD CABLE(40/30/6P,19V)	50.HGLN7.005
CAMERA		
	Camera Tech-Front HD Camera TF_OV9728_RTS5838H_AOET_ZTS6031M Unified2 (add Mic*2)	KS.0HD0Q.003
	Camera Tech-Front HD Camera HD Camera TF_OV9734_SP2087L2_AOET_KMM4030 Unified2 (add Mic*2)	KS.0HD0Q.004
	Camera CHICONY HD Camera HD Camera CH_OV9734_RTS5846N_AOET_SPK0493 Unified2 (add Mic*2)	KS.0HD06.012
CASE/COVER/BRACKET		
	UPPER CASE ASSY Black(Keyboard SV05T_A72B SV5T Internal 15 Standard 100KS Black Arabic acer Font, Power icon, Media key, V0,NK.I1513.111,NK.I1517.0EQ)	6B.HSJN7.001
	UPPER CASE ASSY Black(Keyboard SV05T_A72B SV5T Internal 15 Standard 101KS Black FR/Arabic acer Font, Power icon, Media key, V0,NK.I1513.11J,NK.I1517.0F7)	6B.HSJN7.002
	UPPER CASE ASSY Black(Keyboard SV05T_A72B SV5T Internal 15 Standard 101KS Black Belgium acer Font, Power icon, Media key, V0,NK.I1513.11E,NK.I1517.0F3)	6B.HSJN7.003
	UPPER CASE ASSY Black(Keyboard SV05T_A72B SV5T Internal 15 Standard 101KS Black Brazilian Portuguese acer Font, Power icon, Media key, V0,NK.I1513.11F,NK.I1517.0F4)	6B.HSJN7.004
	UPPER CASE ASSY Black(Keyboard SV05T_A72B SV5T Internal 15 Standard 100KS Black US International w/ Bulgaria acer Font, Power icon, Media key, V0,NK.I1513.11C,NK.I1517.0F1)	6B.HSJN7.005

Table 6-4. FRU List (Continued)

Category	Description	Acer Part No.
	UPPER CASE ASSY Black(Keyboard SV05T_A72B SV5T Internal 15 Standard 100KS Black US International w/ Canadian French acer Font, Power icon, Media key, V0,NK.I1513.11B,NK.I1517.0F0)	6B.HSJN7.006
	UPPER CASE ASSY Black(Keyboard SV05T_A72B SV5T Internal 15 Standard 101KS Black SLO/CRO acer Font, Power icon, Media key, V0,NK.I1513.11S,NK.I1517.0FF)	6B.HSJN7.007
	UPPER CASE ASSY Black(Keyboard SV05T_A72B SV5T Internal 15 Standard 101KS Black CZ/SK acer Font, Power icon, Media key, V0,NK.I1513.11G,NK.I1517.0F5)	6B.HSJN7.008
	UPPER CASE ASSY Black(Keyboard SV05T_A72B SV5T Internal 15 Standard 101KS Black Danish acer Font, Power icon, Media key, V0,NK.I1513.11H,NK.I1517.0F6)	6B.HSJN7.009
	UPPER CASE ASSY Black(Keyboard SV05T_A72B SV5T Internal 15 Standard 101KS Black French acer Font, Power icon, Media key, V0,NK.I1513.11K,NK.I1517.0F8)	6B.HSJN7.010
	UPPER CASE ASSY Black(Keyboard SV05T_A72B SV5T Internal 15 Standard 101KS Black German acer Font, Power icon, Media key, V0,NK.I1513.11L,NK.I1517.0F9)	6B.HSJN7.011
	UPPER CASE ASSY Black(Keyboard SV05T_A72B SV5T Internal 15 Standard 100KS Black Greek acer Font, Power icon, Media key, V0,NK.I1513.113,NK.I1517.0E5)	6B.HSJN7.012
	UPPER CASE ASSY Black(Keyboard SV05T_A72B SV5T Internal 15 Standard 100KS Black US International w/ Hebrew acer Font, Power icon, Media key, V0,NK.I1513.11A,NK.I1517.0EZ)	6B.HSJN7.013
	UPPER CASE ASSY Black(Keyboard SV05T_A72B SV5T Internal 15 Standard 101KS Black Hungarian acer Font, Power icon, Media key, V0,NK.I1513.11M,NK.I1517.0FA)	6B.HSJN7.014
	UPPER CASE ASSY Black(Keyboard SV05T_A72B SV5T Internal 15 Standard 100KS Black Persian acer Font, Power icon, Media key, V0,NK.I1513.117,NK.I1517.0EW)	6B.HSJN7.015

Table 6-4. FRU List (Continued)

Category	Description	Acer Part No.
	UPPER CASE ASSY Black(Keyboard SV05T_A72B SV5T Internal 15 Standard 101KS Black Italian acer Font, Power icon, Media key, V0,NK.I1513.11N,NK.I1517.0FB)	6B.HSJN7.016
	UPPER CASE ASSY Black(Keyboard SV05T_A72B SV5T Internal 15 Standard 104KS Black Japanese acer Font, Power icon, Media key, V0,NK.I1513.11Y,)	6B.HSJN7.017
	UPPER CASE ASSY Black(Keyboard SV05T_A72B SV5T Internal 15 Standard 100KS Black Korean acer Font, Power icon, Media key, V0,NK.I1513.114,NK.I1517.0ET)	6B.HSJN7.018
	UPPER CASE ASSY Black(Keyboard SV05T_A72B SV5T Internal 15 Standard 101KS Black ALA-Spanish acer Font, Power icon, Media key, V0,NK.I1513.11D,NK.I1517.0F2)	6B.HSJN7.019
	UPPER CASE ASSY Black(Keyboard SV05T_A72B SV5T Internal 15 Standard 101KS Black Norwegian acer Font, Power icon, Media key, V0,NK.I1513.11Q,NK.I1517.0FD)	6B.HSJN7.020
	UPPER CASE ASSY Black(Keyboard SV05T_A72B SV5T Internal 15 Standard 101KS Black Portuguese acer Font, Power icon, Media key, V0,NK.I1513.11R,NK.I1517.0FE)	6B.HSJN7.021
	UPPER CASE ASSY Black(Keyboard SV05T_A72B SV5T Internal 15 Standard 100KS Black Russian acer Font, Power icon, Media key, V0,NK.I1513.115,NK.I1517.0EU)	6B.HSJN7.022
	UPPER CASE ASSY Black(Keyboard SV05T_A72B SV5T Internal 15 Standard 101KS Black Nordic acer Font, Power icon, Media key, V0,NK.I1513.11P,NK.I1517.0FC)	6B.HSJN7.023
	UPPER CASE ASSY Black(Keyboard SV05T_A72B SV5T Internal 15 Standard 101KS Black Spanish acer Font, Power icon, Media key, V0,NK.I1513.11T,NK.I1517.0FG)	6B.HSJN7.024
	UPPER CASE ASSY Black(Keyboard SV05T_A72B SV5T Internal 15 Standard 101KS Black Sweden acer Font, Power icon, Media key, V0,NK.I1513.11U,NK.I1517.0FH)	6B.HSJN7.025

Table 6-4. FRU List (Continued)

Category	Description	Acer Part No.
	UPPER CASE ASSY Black(Keyboard SV05T_A72B SV5T Internal 15 Standard 101KS Black Swiss/G acer Font, Power icon, Media key, V0,NK.I1513.11V,NK.I1517.0FJ)	6B.HSJN7.026
	UPPER CASE ASSY Black(Keyboard SV05T_A72B SV5T Internal 15 Standard 100KS Black Thailand acer Font, Power icon, Media key, V0,NK.I1513.118,NK.I1517.0EX)	6B.HSJN7.027
	UPPER CASE ASSY Black(Keyboard SV05T_A72B SV5T Internal 15 Standard 101KS Black Turkish acer Font, Power icon, Media key, V0,NK.I1513.11W,NK.I1517.0FK)	6B.HSJN7.028
	UPPER CASE ASSY Black(Keyboard SV05T_A72B SV5T Internal 15 Standard 100KS Black Traditional Chinese acer Font, Power icon, Media key, V0,NK.I1513.112,NK.I1517.0ER)	6B.HSJN7.029
	UPPER CASE ASSY Black(Keyboard SV05T_A72B SV5T Internal 15 Standard 100KS Black US International acer Font, Power icon, Media key, V0,NK.I1513.119,NK.I1517.0EY)	6B.HSJN7.030
	UPPER CASE ASSY Black(Keyboard SV05T_A72B SV5T Internal 15 Standard 101KS Black UK acer Font, Power icon, Media key, V0,NK.I1513.11X,NK.I1517.0FL)	6B.HSJN7.031
	UPPER CASE ASSY Black(Keyboard SV05T_A72B SV5T Internal 15 Standard 100KS Black Ukrainian acer Font, Power icon, Media key, V0,NK.I1513.116,NK.I1517.0EV)	6B.HSJN7.032
	UPPER CASE ASSY Red(Keyboard SV05T_A72B SV5T Internal 15 Standard 100KS Black Arabic acer Font, Power icon, Media key, V0,NK.I1513.111,NK.I1517.0EQ)	6B.HSTN7.001
	UPPER CASE ASSY Red(Keyboard SV05T_A72B SV5T Internal 15 Standard 101KS Black FR/Arabic acer Font, Power icon, Media key, V0,NK.I1513.11J,NK.I1517.0F7)	6B.HSTN7.002
	UPPER CASE ASSY Red(Keyboard SV05T_A72B SV5T Internal 15 Standard 101KS Black Belgium acer Font, Power icon, Media key, V0,NK.I1513.11E,NK.I1517.0F3)	6B.HSTN7.003

Table 6-4. FRU List (Continued)

Category	Description	Acer Part No.
	UPPER CASE ASSY Red(Keyboard SV05T_A72B SV5T Internal 15 Standard 101KS Black Spanish acer Font, Power icon, Media key, V0,NK.I1513.11T,NK.I1517.0FG)	6B.HSTN7.024
	UPPER CASE ASSY Red(Keyboard SV05T_A72B SV5T Internal 15 Standard 101KS Black Sweden acer Font, Power icon, Media key, V0,NK.I1513.11U,NK.I1517.0FH)	6B.HSTN7.025
	UPPER CASE ASSY Red(Keyboard SV05T_A72B SV5T Internal 15 Standard 101KS Black Swiss/G acer Font, Power icon, Media key, V0,NK.I1513.11V,NK.I1517.0FJ)	6B.HSTN7.026
	UPPER CASE ASSY Red(Keyboard SV05T_A72B SV5T Internal 15 Standard 100KS Black Thailand acer Font, Power icon, Media key, V0,NK.I1513.118,NK.I1517.0EX)	6B.HSTN7.027
	UPPER CASE ASSY Red(Keyboard SV05T_A72B SV5T Internal 15 Standard 101KS Black Turkish acer Font, Power icon, Media key, V0,NK.I1513.11W,NK.I1517.0FK)	6B.HSTN7.028
	UPPER CASE ASSY Red(Keyboard SV05T_A72B SV5T Internal 15 Standard 100KS Black Traditional Chinese acer Font, Power icon, Media key, V0,NK.I1513.112,NK.I1517.0ER)	6B.HSTN7.029
	UPPER CASE ASSY Red(Keyboard SV05T_A72B SV5T Internal 15 Standard 100KS Black US International acer Font, Power icon, Media key, V0,NK.I1513.119,NK.I1517.0EY)	6B.HSTN7.030
	UPPER CASE ASSY Red(Keyboard SV05T_A72B SV5T Internal 15 Standard 101KS Black UK acer Font, Power icon, Media key, V0,NK.I1513.11X,NK.I1517.0FL)	6B.HSTN7.031
	UPPER CASE ASSY Red(Keyboard SV05T_A72B SV5T Internal 15 Standard 100KS Black Ukrainian acer Font, Power icon, Media key, V0,NK.I1513.116,NK.I1517.0EV)	6B.HSTN7.032
	UPPER CASE ASSY Silver(Keyboard SV05T_A72B SV5T Internal 15 Standard 100KS Black Arabic acer Font, Power icon, Media key, V0,NK.I1513.111,NK.I1517.0EQ)	6B.HSNN7.001

Table 6-4. FRU List (Continued)

Category	Description	Acer Part No.
	UPPER CASE ASSY Silver(Keyboard SV05T_A72B SV5T Internal 15 Standard 100KS Black Ukrainian acer Font, Power icon, Media key, V0,NK.I1513.116,NK.I1517.0EV)	6B.HSNN7.032
	UPPER CASE ASSY Black(Keyboard CHICONY SV05P_A72BWL SV5P Internal 15 Standard 100KS Black Arabic acer Font, White BL, Power icon, Media key, V0,NK.I1513.103,)	6B.HSKN7.001
	UPPER CASE ASSY Black(Keyboard CHICONY SV05P_A72BWL SV5P Internal 15 Standard 101KS Black FR/Arabic acer Font, White BL, Power icon, Media key, V0,NK.I1513.10L,)	6B.HSKN7.002
	UPPER CASE ASSY Black(Keyboard CHICONY SV05P_A72BWL SV5P Internal 15 Standard 101KS Black Belgium acer Font, White BL, Power icon, Media key, V0,NK.I1513.10G,)	6B.HSKN7.003
	UPPER CASE ASSY Black(Keyboard CHICONY SV05P_A72BWL SV5P Internal 15 Standard 101KS Black Brazilian Portuguese acer Font, White BL, Power icon, Media key, V0,NK.I1513.10H,)	6B.HSKN7.004
	UPPER CASE ASSY Black(Keyboard CHICONY SV05P_A72BWL SV5P Internal 15 Standard 100KS Black US International w/ Bulgaria acer Font, White BL, Power icon, Media key, V0,NK.I1513.10E,)	6B.HSKN7.005
	UPPER CASE ASSY Black(Keyboard CHICONY SV05P_A72BWL SV5P Internal 15 Standard 100KS Black US International w/ Canadian French acer Font, White BL, Power icon, Media key, V0,NK.I1513.10D,)	6B.HSKN7.006
	UPPER CASE ASSY Black(Keyboard CHICONY SV05P_A72BWL SV5P Internal 15 Standard 101KS Black SLO/CRO acer Font, White BL, Power icon, Media key, V0,NK.I1513.10U,)	6B.HSKN7.007
	UPPER CASE ASSY Black(Keyboard CHICONY SV05P_A72BWL SV5P Internal 15 Standard 101KS Black CZ/SK acer Font, White BL, Power icon, Media key, V0,NK.I1513.10J,)	6B.HSKN7.008
	UPPER CASE ASSY Black(Keyboard CHICONY SV05P_A72BWL SV5P Internal 15 Standard 101KS Black Danish acer Font, White BL, Power icon, Media key, V0,NK.I1513.10K,)	6B.HSKN7.009

Table 6-4. FRU List (Continued)

Category	Description	Acer Part No.
	UPPER CASE ASSY Black(Keyboard CHICONY SV05P_A72BWL SV5P Internal 15 Standard 101KS Black UK acer Font, White BL, Power icon, Media key, V0,NK.I1513.10Z,)	6B.HSKN7.031
	UPPER CASE ASSY Black(Keyboard CHICONY SV05P_A72BWL SV5P Internal 15 Standard 100KS Black Ukrainian acer Font, White BL, Power icon, Media key, V0,NK.I1513.108,)	6B.HSKN7.032
	UPPER CASE ASSY Red(Keyboard CHICONY SV05P_A72BWL SV5P Internal 15 Standard 100KS Black Arabic acer Font, White BL, Power icon, Media key, V0,NK.I1513.103,)	6B.HSUN7.001
	UPPER CASE ASSY Red(Keyboard CHICONY SV05P_A72BWL SV5P Internal 15 Standard 101KS Black FR/Arabic acer Font, White BL, Power icon, Media key, V0,NK.I1513.10L,)	6B.HSUN7.002
	UPPER CASE ASSY Red(Keyboard CHICONY SV05P_A72BWL SV5P Internal 15 Standard 101KS Black Belgium acer Font, White BL, Power icon, Media key, V0,NK.I1513.10G,)	6B.HSUN7.003
	UPPER CASE ASSY Red(Keyboard CHICONY SV05P_A72BWL SV5P Internal 15 Standard 101KS Black Brazilian Portuguese acer Font, White BL, Power icon, Media key, V0,NK.I1513.10H,)	6B.HSUN7.004
	UPPER CASE ASSY Red(Keyboard CHICONY SV05P_A72BWL SV5P Internal 15 Standard 100KS Black US International w/ Bulgaria acer Font, White BL, Power icon, Media key, V0,NK.I1513.10E,)	6B.HSUN7.005
	UPPER CASE ASSY Red(Keyboard CHICONY SV05P_A72BWL SV5P Internal 15 Standard 100KS Black US International w/ Canadian French acer Font, White BL, Power icon, Media key, V0,NK.I1513.10D,)	6B.HSUN7.006
	UPPER CASE ASSY Red(Keyboard CHICONY SV05P_A72BWL SV5P Internal 15 Standard 101KS Black SLO/CRO acer Font, White BL, Power icon, Media key, V0,NK.I1513.10U,)	6B.HSUN7.007
	UPPER CASE ASSY Red(Keyboard CHICONY SV05P_A72BWL SV5P Internal 15 Standard 101KS Black CZ/SK acer Font, White BL, Power icon, Media key, V0,NK.I1513.10J,)	6B.HSUN7.008

Table 6-4. FRU List (Continued)

Category	Description	Acer Part No.
	UPPER CASE ASSY Red(Keyboard CHICONY SV05P_A72BWL SV5P Internal 15 Standard 100KS Black US International acer Font, White BL, Power icon, Media key, V0,NK.I1513.10B,)	6B.HSUN7.030
	UPPER CASE ASSY Red(Keyboard CHICONY SV05P_A72BWL SV5P Internal 15 Standard 101KS Black UK acer Font, White BL, Power icon, Media key, V0,NK.I1513.10Z,)	6B.HSUN7.031
	UPPER CASE ASSY Red(Keyboard CHICONY SV05P_A72BWL SV5P Internal 15 Standard 100KS Black Ukrainian acer Font, White BL, Power icon, Media key, V0,NK.I1513.108,)	6B.HSUN7.032
	UPPER CASE ASSY Silver(Keyboard CHICONY SV05P_A72BWL SV5P Internal 15 Standard 100KS Black Arabic acer Font, White BL, Power icon, Media key, V0,NK.I1513.103,)	6B.HSPN7.001
	UPPER CASE ASSY Silver(Keyboard CHICONY SV05P_A72BWL SV5P Internal 15 Standard 101KS Black FR/Arabic acer Font, White BL, Power icon, Media key, V0,NK.I1513.10L,)	6B.HSPN7.002
	UPPER CASE ASSY Silver(Keyboard CHICONY SV05P_A72BWL SV5P Internal 15 Standard 101KS Black Belgium acer Font, White BL, Power icon, Media key, V0,NK.I1513.10G,)	6B.HSPN7.003
	UPPER CASE ASSY Silver(Keyboard CHICONY SV05P_A72BWL SV5P Internal 15 Standard 101KS Black Brazilian Portuguese acer Font, White BL, Power icon, Media key, V0,NK.I1513.10H,)	6B.HSPN7.004
	UPPER CASE ASSY Silver(Keyboard CHICONY SV05P_A72BWL SV5P Internal 15 Standard 100KS Black US International w/ Bulgaria acer Font, White BL, Power icon, Media key, V0,NK.I1513.10E,)	6B.HSPN7.005
	UPPER CASE ASSY Silver(Keyboard CHICONY SV05P_A72BWL SV5P Internal 15 Standard 100KS Black US International w/ Canadian French acer Font, White BL, Power icon, Media key, V0,NK.I1513.10D,)	6B.HSPN7.006
	UPPER CASE ASSY Silver(Keyboard CHICONY SV05P_A72BWL SV5P Internal 15 Standard 101KS Black SLO/CRO acer Font, White BL, Power icon, Media key, V0,NK.I1513.10U,)	6B.HSPN7.007

Table 6-4. FRU List (Continued)

Category	Description	Acer Part No.
	UPPER CASE ASSY Silver(Keyboard CHICONY SV05P_A72BWL SV5P Internal 15 Standard 100KS Black US International acer Font, White BL, Power icon, Media key, V0,NK.I1513.10B,)	6B.HSPN7.030
	UPPER CASE ASSY Silver(Keyboard CHICONY SV05P_A72BWL SV5P Internal 15 Standard 101KS Black UK acer Font, White BL, Power icon, Media key, V0,NK.I1513.10Z,)	6B.HSPN7.031
	UPPER CASE ASSY Silver(Keyboard CHICONY SV05P_A72BWL SV5P Internal 15 Standard 100KS Black Ukrainian acer Font, White BL, Power icon, Media key, V0,NK.I1513.108,)	6B.HSPN7.032
	LOWER CASE ASSY BLACK	60.HGLN7.001
	LOWER CASE ASSY SILVER	60.HFQN7.001
	LOWER CASE ASSY RED	60.HFSN7.001
	HDD BRACKET	33.HGLN7.001
	LCD COVER ASSY GREY	60.HGLN7.002
	LCD COVER ASSY SILVER	60.HFQN7.002
	LCD COVER ASSY RED	60.HFSN7.002
	LCD BEZEL (W/HINGE CAP)GREY	60.HGLN7.003
	LCD BEZEL (W/HINGE CAP)SILVER	60.HFQN7.003
	LCD BEZEL (W/HINGE CAP)RED	60.HFSN7.003
	HINGE L	33.HGLN7.002
	HINGE R	33.HGLN7.003

Table 6-4. FRU List (Continued)

Category	Description	Acer Part No.
FAN		
	FAN DC 5V	23.HGLN7.001
HARD DISK DRIVE		
	HDD WD 2.5" 5400rpm 1000GB WD10SPZX-21Z10T0 , 7mmzh 1D , 1TB/P , MN1000S SATA III 128MB LF F/W: 02.01A02	KH.01K08.035
	HDD SEAGATE 2.5" 5400rpm 1000GB ST1000LM035 ,1RK172-190 ,Rosewood 1TB ,7mmzh HDD - SATA III 128MB LF F/W:ACM2	KH.01K01.065
	HDD WD 2.5" 5400rpm 2000GB WD20SPZX-21UA7T0 , 7mmzh 2D , 1TB/P , MN1000M SATA III 128MB LF F/W:01.01A01	KH.02K08.020
	Flash Disk KINGSTON SSD NAND 128GB RBU-SNS8154P3/128GJ1 LF+HF	KN.12807.029
	Flash Disk KINGSTON SSD NAND 256GB RBU-SNS8154P3/256GJ1 LF+HF	KN.25607.025
	Flash Disk SANDISK SSD NAND 512GB SDAPNUW-512G-1014 LF+HF	KN.5120D.004
	System Accelerator INTEL M_2 3D X-Point 16GB MEMPEK1J016GA01 (SB2) LF+HF	KN.16G0N.003
HEATSINK		
	HEAT SINK UMA	24.HGLN7.002
LCD		
	LED LCD Panel CMI 15.6"W WXGA None Glare N156BGA-EA3 LF 220nit 10ms 500:1 (eDP, 3.2mm Max,narrow border)	KL.1560D.034
	LED LCD Panel AUO 15.6"W WXGA None Glare B156XTN08.1 LF 220nit 8ms 400:1 (eDP, 3.2mm Max, narrow border)	KL.15605.048
	LED LCD Panel AUO 15.6"W FHD None Glare B156HAN02.1 LF 250nit 25ms 700:1 (eDP, value IPS, narrow border)	KL.15605.040

Table 6-4. FRU List (Continued)







Category	Description	Acer Part No.
	LED LCD Panel AUO 15.6"W FHD None Glare B156HTN06.1 LF 220nit 8ms 400:1 (eDP, narrow border, 3.2mm max, value)	KL.15605.050
	LED LCD Panel CMI 15.6"W FHD None Glare N156HGA-EA3 LF 220nit 10ms 500:1 (eDP, narrow border, 3.2mm max, value)	KL.1560D.035
	LED LCD Panel BOE 15.6"W FHD None Glare NT156FHM-N61 LF 220nit 10ms 500:1 (eDP, narrow border, 3.2mm max, value)	KL.1560E.015
	LED LCD Panel Panda 15.6"W FHD None Glare LM156LFCL03 LF 220nit 25ms 1000:1 (eDP, value IPS, narrow border)	KL.15603.004
MAINBOARD		
	Mainboard A515-55 Intel Ci5-1035G1 4GB UMA KB BL	NB.HSM11.002
	Mainboard A515-55 Intel i3-1005G1 4GB UMA KB BL	NB.HSM11.001
	Mainboard A515-55 Intel i5-1035G1 4GB UMA	NB.HSN11.002
	Mainboard A515-55 Intel i3-1005G1 4GB UMA	NB.HSN11.001
	Mainboard A515-55 Intel i3-1005G1 4GB UMA w/FP	NB.HSN11.003
	Mainboard A515-55 Intel i5-1035G1 4GB UMA w/FP	NB.HSN11.004
	Mainboard A515-55 Intel i3-1005G1 4GB UMA KB BL w/FP	NB.HSP11.001
	Mainboard A515-55 Intel Ci5-1035G1 4GB UMA KB BL w/FP	NB.HSP11.002
MEMORY		
	Memory KINGSTON SO-DIMM DDRIV 2666 4GB ACR26D4S9S1KA-4 LF+HF 512*16 NA-A	KN.4GB07.043
	Memory MICRON SO-DIMM DDRIV 3200 4GB MTA4ATF51264HZ-3G2J1 LF+HF 512*16 Z21C	KN.4GB04.022
	Memory HYNIX SO-DIMM DDRIV 2666 4GB HMA851S6CJR6N-VK LF+HF 512*16 1Xnm, AL	KN.4GB0G.049
	Memory HYNIX SO-DIMM DDRIV 2666 8GB HMA81GS6CJR8N-VK LF+HF 1024*8 1Xnm, AL	KN.8GB0G.058

Table 6-4. FRU List (Continued)

Category	Description	Acer Part No.
	Memory MICRON SO-DIMM DDRIV 3200 8GB MTA8ATF1G64HZ-3G2J1 LF+HF 1024*8 Z21C	KN.8GB04.044
	Memory HYNIX SO-DIMM DDRIV 2400 8GB HMA81GS6AFR8N-UH LF+HF 1024*8 21nm Deneb	KN.8GB0G.046
	Memory KINGSTON SO-DIMM DDRIV 2666 16GB ACR26D4S9D8ME-16 LF+HF 1024*8	KN.16G07.028
	Memory HYNIX SO-DIMM DDRIV 2666 16GB HMA82GS6CJR8N-VK LF+HF 1024*8 1Xnm, AL	KN.16G0G.031
POWER CORD		
	POWER CORD 1M 125V JAP BLACK	27.NE307.001
	POWER CORD 1M 125V ARG BLACK	27.NE307.004
	POWER CORD 1M 125V AUS BLACK	27.NE307.005
	POWER CORD 1M 125V BRAZIL BLACK	27.NE307.006
	POWER CORD 1M 125V CHINA BLACK	27.NE307.007
	POWER CORD 1M 125V DENMARK BLACK	27.NE307.008
	POWER CORD 1M 125V INDIA BLACK	27.NE307.009
	POWER CORD 1M 125V ISRAEL BLACK	27.NE307.010
	POWER CORD 1M 125V ITL BLACK	27.NE307.011
	POWER CORD 1M 125V S.AFRICA BLACK	27.NE307.012
	POWER CORD 1M 125V SWISS BLACK	27.NE307.013
	POWER CORD 1M 125V EUR+KOR BLACK	27.NE307.015
	POWER CORD 1M 125V US BLACK	27.NE307.003
	POWER CORD 1M 125V UK BLACK	27.NE307.014
POWER CORD 1M 125V TAIWAN BLACK	27.NE307.002	
SPEAKER		
	SPEAKER (W-L/R)	23.HGLN7.002





Table 6-4. FRU List (Continued)

Category	Description	Acer Part No.
MISCELLANEOUS		
	LCD ADHESIVE TAPE	47.HGLN7.001
	RUBBER FOR MIC	47.HGLN7.002
	CONDUCTIVE FABRIC	47.HGLN7.003
	INSULATOR MYLAR FOR MB	47.HGKN7.002
	ACETATE TAPE FOR BATTERY(21*21mm)	47.HKKN7.001
	ACETATE TAPE FOR KEYBOARD	47.HNBN7.001

Screw List





Aspire A515-54/A515-54G

Table 6-5. Screw List

CATEGORY	Description	Acer Part No.
	SCREWM2*2.5-I(BNI)(NYLOK)D7T0.3IRON	86.GE8N7.001
	SCREW M2.0*3.0-I(BZN)(NYLOK)IRON	86.GDEN7.001
	SCREWM2.5*1.8-I(NINYLOK)D5T3.7STEEL	86.GDEN7.002
	SCREW M2.5*6-I(BNI)(NYLOK)IRON	86.SHXN7.004
	SCREW M3*0.5+3.5I	86.TDY07.003

Aspire A515-55

Table 6-6. Screw List

CATEGORY	Description	Acer Part No.
	SCREWM2*2.5-I(BNI)(NYLOK)D7T0.3IRON	86.GE8N7.001
	SCREW M2*2.8-IBNI(NYLOK(D5,T0.5STEEL	86.HG6N7.001
	SCREWM2.5*1.8-I(NINYLOK)D5T3.7STEEL	86.GDEN7.002
	SCREW M2.5*6-I(BNI)(NYLOK)IRON	86.SHXN7.004
	SCREW M3*0.5+3.5I	86.TDY07.003