

# Exploded Diagram

## Main Assembly

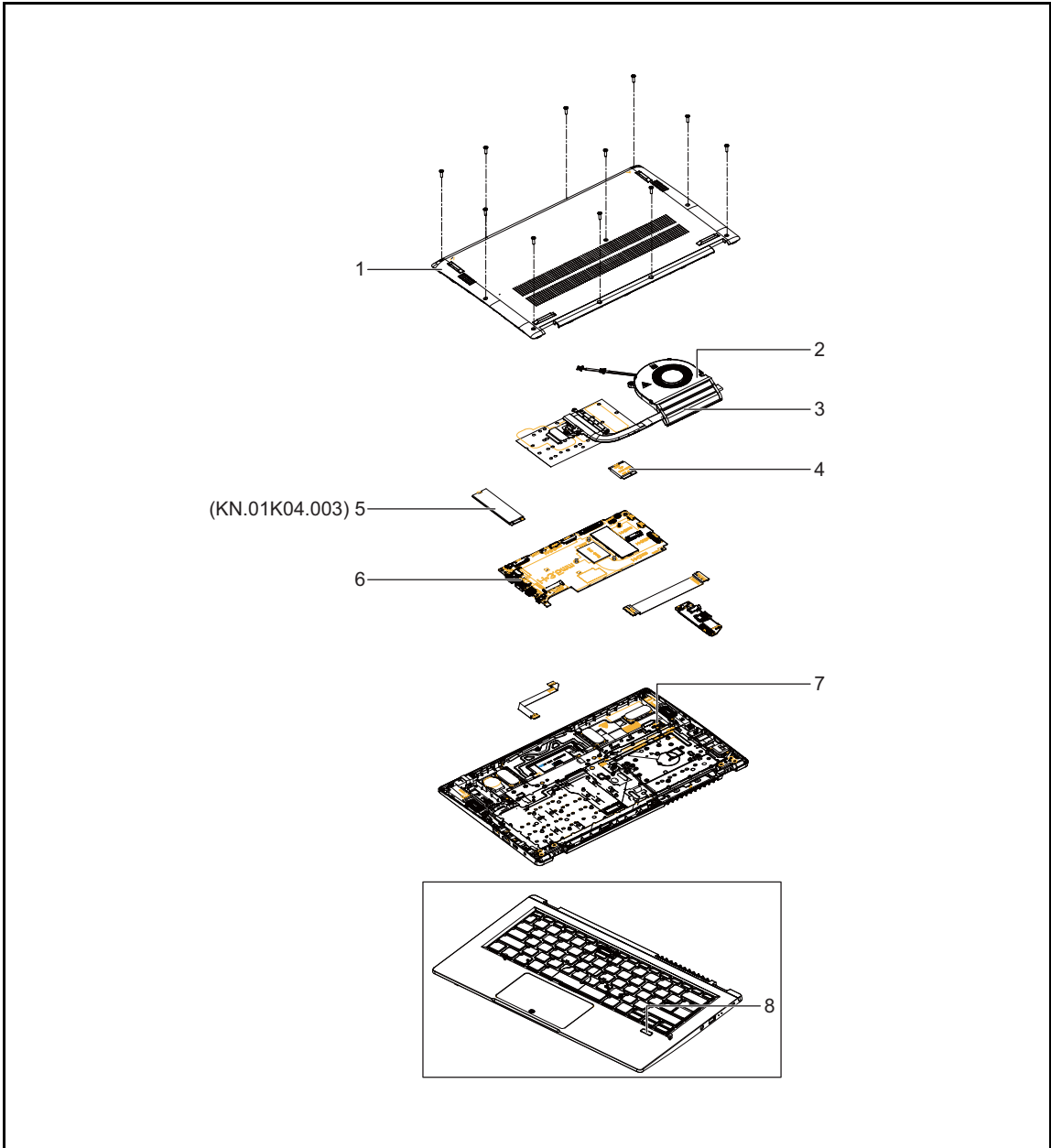

Figure 6-1. Main Assembly Exploded Diagram

Table 6-1. Main Assembly Exploded Diagram

No.	Description	P/N
1	LOWER CASE ASSY - SILVER	60.AB2N2.001
2	FAN	23.AB2N2.001

**Table 6-1. Main Assembly Exploded Diagram**

<b>No.</b>	<b>Description</b>	<b>P/N</b>
3	THERMAL MODULE UMA W/O FAN	24.AB2N2.001
4	Wireless LAN MEDIATEK 802.11ax Bluetooth FM MT7921LE WiFi 6 2x2 AX+BT M.2 2230	KE.11X0M.001
5	Flash Disk MICRON SSD NAND 1024GB M.2 2280 2210 MTFDHBA1T0QFD-1AX15ABYY LF+HF	KN.01K04.003
6	Mainboard	TBD
7	BRACKET FOR FP	33.AB2N2.003
8	FP BOARD	55.AB2N2.002

# Upper Cover Assembly

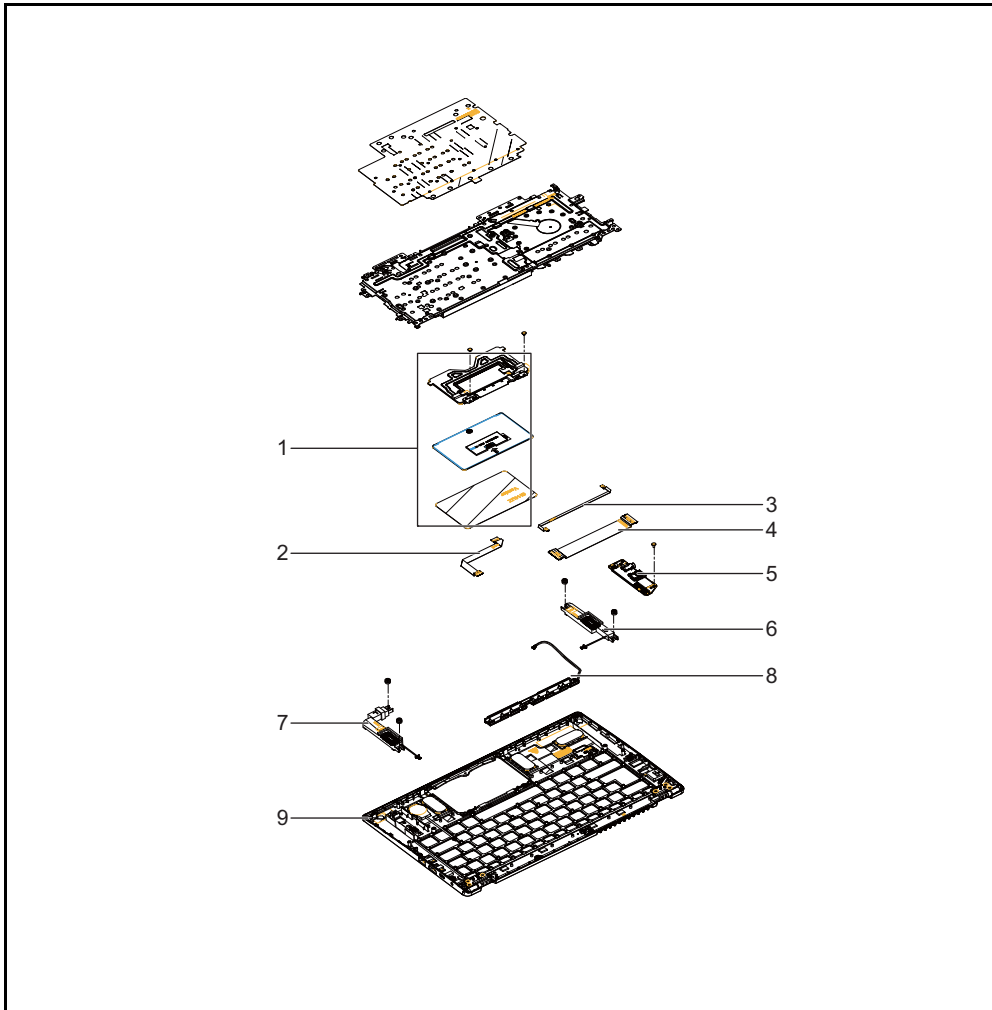

**Figure 6-2. Upper Cover Assembly Exploded Diagram**

**Table 6-2. Upper Cover Assembly Exploded Diagram**

No.	Description	P/N
1	TOUCHPAD ASSY SILVER-SYNAPTICS	56.AB2N2.001
2	FFC CABLE FOR TP	50.AB2N2.002
3	FFC CABLE FOR FP	50.AB2N2.003
4	FFC CABLE FOR IO BOARD	50.AB2N2.001
5	IO BOARD FOR UMA	55.AB2N2.001
6	SPEAKER R	23.AB2N2.003
7	SPEAKER L	23.AB2N2.002
8	ANTENNA WLAN MAIN & AUX	50.AB2N2.004

**Table 6-2. Upper Cover Assembly Exploded Diagram**

<b>No.</b>	<b>Description</b>	<b>P/N</b>
9	UPPER CASE ASSY SILVER W/NBL(Keyboard SV03T_A84B SV3T Internal 13 Standard 83KS Black US International acer P font power icon V0, NK.I1313.1L1, NK.I131S.0EN, NK.I1317.08X)	6B.AB2N2.001

# LCD Assembly

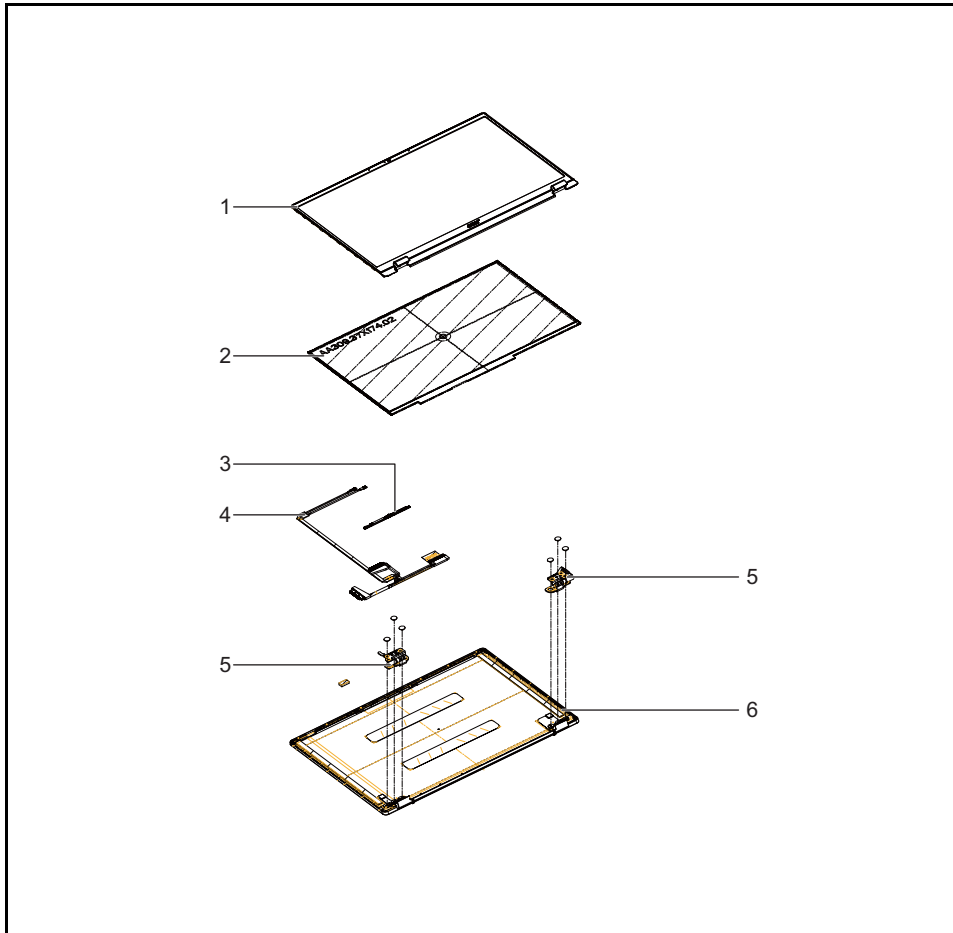







**Figure 6-3. LCD Assembly Exploded Diagram**

**Table 6-3. LCD Assembly Exploded Diagram**

No.	Description	P/N
1	LCD BEZEL SILVER	60.AB2N2.005
2	LED LCD Panel CMI 14' FHD None Glare N140HCE-EN2 LF 300nit 25ms 700:1 (eDP, IPS, narrow border, 2.4mm Max)	KL.1400D.024
3	Camera CHICONY HD Camera CH_GC1009_RTS5846N_Powertip_ZTS6735_Windows Y3.2mm (dual Mic distance 66mm)	KS.0HD06.019
4	LCD EDP CABLE	50.AB2N2.005
5	LCD HINGE L	33.AB2N2.001
	LCD HINGE R	33.AB2N2.002
6	LCD COVER SILVER FOR 3.0mm PANEL	60.AB2N2.002

# FRU List

**Table 6-4. FRU List**

CATEGORY	Acer Description	AcerPN
<b>BOARD</b>		
	IO BOARD FOR UMA	55.AB2N2.001
	FP BOARD	55.AB2N2.002
<b>CABLE</b>		
	FFC CABLE FOR IO BOARD	50.AB2N2.001
	FFC CABLE FOR TP	50.AB2N2.002
	FFC CABLE FOR FP	50.AB2N2.003
	ANTENNA WLAN MAIN & AUX	50.AB2N2.004
	LCD EDP CABLE	50.AB2N2.005
	POWER CORD 1M BLACK SOUTH AFRICA - NEW	27.HEEN2.001

CATEGORY	Acer Description	AcerPN
	POWER CORD 1M BLACK BLACK AUSTRALIA	27.Q28N2.002
	POWER CORD 1M BLACK EU	27.Q28N2.003
	POWER CORD 1M BLACK EU(New source)	27.Q7DN2.001
	POWER CORD 1M BLACK DENMARK	27.Q28N2.004
	POWER CORD 1M BLACK ISRAEL	27.Q28N2.005
	POWER CORD 1M BLACK ITALIAN	27.Q28N2.006
	POWER CORD 1M BLACK JAPAN	27.Q28N2.007
	POWER CORD 1M BLACK CHINA - NEW	27.HEEN2.002
	POWER CORD 1M BLACK INDIA	27.Q28N2.009
	POWER CORD 1M BLACK SWISS	27.Q28N2.010
	POWER CORD 1M BLACK UK	27.Q28N2.011
	POWER CORD 1M BLACK UK(New source)	27.Q7DN2.002
	POWER CORD 1M BLACK TWN	27.Q28N2.012
	POWER CORD 1M BLACK ARGENTINA - NEW	27.HEEN2.003
	POWER CORD 1M BLACK KOREA	27.Q28N2.014
	POWER CORD 1M BLACK US	27.Q28N2.015
	POWER CORD 1M BLACK US(New source)	27.Q7DN2.003
	POWER CORD 1M BLACK BRAZIL	27.Q28N2.016
<b>CASE/COVER/BRACKET ASSEMBLY</b>		
	LOWER CASE ASSY - SILVER	60.AB2N2.001
	LOWER CASE ASSY - ELECTRIC BLUE	60.ACQN2.001
	LOWER CASE ASSY - STEAM BLUE	60.AB6N2.001
	LOWER CASE ASSY - RED	TBD
	LCD COVER SILVER FOR 3.0mm PANEL	60.AB2N2.002
	LCD COVER SILVER FOR 2.4mm PANEL	60.AB2N2.003
	LCD COVER SILVER FOR 2.1mm PANEL	60.AB2N2.004
	LCD COVER ELECTRIC BLUE FOR 3.0mm PANEL	60.ACQN2.002
	LCD COVER ELECTRIC BLUE FOR 2.4mm PANEL	60.ACQN2.003
	LCD COVER ELECTRIC BLUE FOR 2.1mm PANEL	60.ACQN2.004

CATEGORY	Acer Description	AcerPN
	LCD COVER STEAM BLUE FOR 3.0mm PANEL	60.AB6N2.002
	LCD COVER STEAM BLUE FOR 2.4mm PANEL	60.AB6N2.003
	LCD COVER STEAM BLUE FOR 2.1mm PANEL	60.AB6N2.004
	LCD COVER RED FOR 3.0mm PANEL	TBD
	LCD COVER RED FOR 2.4mm PANEL	TBD
	LCD COVER RED FOR 2.1mm PANEL	TBD
	LCD BEZEL SILVER	60.AB2N2.005
	LCD BEZEL ELECTRIC BLUE	60.ACQN2.005
	LCD BEZEL STEAM BLUE	60.AB6N2.005
	LCD BEZEL RED	TBD
	LCD HINGE L	33.AB2N2.001
	LCD HINGE R	33.AB2N2.002
	BRACKET FOR FP	33.AB2N2.003
<b>FAN</b>		
	FAN	23.AB2N2.001
<b>HEATSINK</b>		
	THERMAL MODULE UMA W/O FAN	24.AB2N2.001
<b>KB ASSEMBLY</b>		
	UPPER CASE ASSY SILVER W/NBL(Keyboard SV03T_A84B SV3T Internal 13 Standard 83KS Black US International acer P font power icon V0,NK.I1313.1L1,NK.I131S.0EN,NK.I1317.08X)	6B.AB2N2.001
	UPPER CASE ASSY SILVER W/NBL(Keyboard SV03T_A84B SV3T Internal 13 Standard 83KS Black Greek acer P font power icon V0,NK.I1313.1KV,NK.I131S.0EG,NK.I1317.08R)	6B.AB2N2.002





CATEGORY	Acer Description	AcerPN
	UPPER CASE ASSY SILVER W/NBL(Keyboard SV03T_A84B SV3T Internal 13 Standard 83KS Black Arabic acer P font power icon V0, NK.I1313.1KT, NK.I131S.0EE, NK.I1317.08P)	6B.AB2N2.003
	UPPER CASE ASSY SILVER W/NBL(Keyboard SV03T_A84B SV3T Internal 13 Standard 83KS Black Traditional Chinese acer P font power icon V0,NK.I1313.1KU,NK.I131S.0EF,NK.I1317.08Q)	6B.AB2N2.004
	UPPER CASE ASSY SILVER W/NBL(Keyboard SV03T_A84B SV3T Internal 13 Standard 83KS Black Russian acer P font power icon V0,NK.I1313.1KX,NK.I131S.0EJ,NK.I1317.08T)	6B.AB2N2.005
	UPPER CASE ASSY SILVER W/NBL(Keyboard SV03T_A84B SV3T Internal 13 Standard 83KS Black US International w/ Hebrew acer P font power icon V0, NK.I1313.1L2, NK.I131S.0EP, NK.I1317.08Y)	6B.AB2N2.006
	UPPER CASE ASSY SILVER W/NBL(Keyboard SV03T_A84B SV3T Internal 13 Standard 83KS Black Thailand acer P font power icon V0, NK.I1313.1L0, NK.I131S.0EM, NK.I1317.08W)	6B.AB2N2.007
	UPPER CASE ASSY SILVER W/NBL(Keyboard SV03T_A84B SV3T Internal 13 Standard 83KS Black Korean acer P font power icon V0, NK.I1313.1KW, NK.I131S.0EH, NK.I1317.08S)	6B.AB2N2.008
	UPPER CASE ASSY SILVER W/NBL(Keyboard SV03T_A84B SV3T Internal 13 Standard 83KS Black Ukrainian acer P font power icon V0, NK.I1313.1KY, NK.I131S.0EK, NK.I1317.08U)	6B.AB2N2.009
	UPPER CASE ASSY SILVER W/NBL(Keyboard SV03T_A84B SV3T Internal 13 Standard 83KS Black Persian acer P font power icon V0, NK.I1313.1KZ, NK.I131S.0EL, NK.I1317.08V)	6B.AB2N2.010
	UPPER CASE ASSY SILVER W/NBL(Keyboard SV03T_A84B SV3T Internal 13 Standard 83KS Black US International w/ Canadian French acer P font power icon V0, NK.I1313.1L3, NK.I131S.0EQ, NK.I1317.08Z)	6B.AB2N2.011
	UPPER CASE ASSY SILVER W/NBL(Keyboard SV03T_A84B SV3T Internal 13 Standard 83KS Black US International w/ Bulgaria acer P font power icon V0, NK.I1313.1L4, NK.I131S.0ER, NK.I1317.090)	6B.AB2N2.012

CATEGORY	Acer Description	AcerPN
	UPPER CASE ASSY ELECTRIC BLUE W/ NBL(Keyboard SV03T_A84B SV3T Internal 13 Standard 83KS Black Greek acer P font power icon V0, NK.I1313.1KV, NK.I131S.0EG, NK.I1317.08R)	6B.ACQN2.002
	UPPER CASE ASSY ELECTRIC BLUE W/ NBL(Keyboard SV03T_A84B SV3T Internal 13 Standard 83KS Black Arabic acer P font power icon V0, NK.I1313.1KT, NK.I131S.0EE, NK.I1317.08P)	6B.ACQN2.003
	UPPER CASE ASSY ELECTRIC BLUE W/ NBL(Keyboard SV03T_A84B SV3T Internal 13 Standard 83KS Black Traditional Chinese acer P font power icon V0, NK.I1313.1KU, NK.I131S.0EF, NK.I1317.08Q)	6B.ACQN2.004
	UPPER CASE ASSY ELECTRIC BLUE W/ NBL(Keyboard SV03T_A84B SV3T Internal 13 Standard 83KS Black Russian acer P font power icon V0, NK.I1313.1KX, NK.I131S.0EJ, NK.I1317.08T)	6B.ACQN2.005
	UPPER CASE ASSY ELECTRIC BLUE W/ NBL(Keyboard SV03T_A84B SV3T Internal 13 Standard 83KS Black US International w/ Hebrew acer P font power icon V0, NK.I1313.1L2, NK.I131S.0EP, NK.I1317.08Y)	6B.ACQN2.006
	UPPER CASE ASSY ELECTRIC BLUE W/ NBL(Keyboard SV03T_A84B SV3T Internal 13 Standard 83KS Black Thailand acer P font power icon V0, NK.I1313.1L0, NK.I131S.0EM, NK.I1317.08W)	6B.ACQN2.007
	UPPER CASE ASSY ELECTRIC BLUE W/ NBL(Keyboard SV03T_A84B SV3T Internal 13 Standard 83KS Black Korean acer P font power icon V0, NK.I1313.1KW, NK.I131S.0EH, NK.I1317.08S)	6B.ACQN2.008
	UPPER CASE ASSY ELECTRIC BLUE W/ NBL(Keyboard SV03T_A84B SV3T Internal 13 Standard 83KS Black Ukrainian acer P font power icon V0, NK.I1313.1KY, NK.I131S.0EK, NK.I1317.08U)	6B.ACQN2.009
	UPPER CASE ASSY ELECTRIC BLUE W/ NBL(Keyboard SV03T_A84B SV3T Internal 13 Standard 83KS Black Persian acer P font power icon V0, NK.I1313.1KZ, NK.I131S.0EL, NK.I1317.08V)	6B.ACQN2.010

CATEGORY	Acer Description	AcerPN
	UPPER CASE ASSY STEAM BLUE W/ NBL(Keyboard SV03T_A84B SV3T Internal 13 Standard 83KS Black US International w/ Hebrew acer P font power icon V0, NK.I1313.1L2, NK.I131S.0EP, NK.I1317.08Y)	6B.AB6N2.006
	UPPER CASE ASSY STEAM BLUE W/ NBL(Keyboard SV03T_A84B SV3T Internal 13 Standard 83KS Black Thailand acer P font power icon V0, NK.I1313.1L0, NK.I131S.0EM, NK.I1317.08W)	6B.AB6N2.007
	UPPER CASE ASSY STEAM BLUE W/ NBL(Keyboard SV03T_A84B SV3T Internal 13 Standard 83KS Black Korean acer P font power icon V0, NK.I1313.1KW, NK.I131S.0EH, NK.I1317.08S)	6B.AB6N2.008
	UPPER CASE ASSY STEAM BLUE W/ NBL(Keyboard SV03T_A84B SV3T Internal 13 Standard 83KS Black Ukrainian acer P font power icon V0, NK.I1313.1KY, NK.I131S.0EK, NK.I1317.08U)	6B.AB6N2.009
	UPPER CASE ASSY STEAM BLUE W/ NBL(Keyboard SV03T_A84B SV3T Internal 13 Standard 83KS Black Persian acer P font power icon V0, NK.I1313.1KZ, NK.I131S.0EL, NK.I1317.08V)	6B.AB6N2.010
	UPPER CASE ASSY STEAM BLUE W/ NBL(Keyboard SV03T_A84B SV3T Internal 13 Standard 83KS Black US International w/ Canadian French acer P font power icon V0, NK.I1313.1L3, NK.I131S.0EQ, NK.I1317.08Z)	6B.AB6N2.011
	UPPER CASE ASSY STEAM BLUE W/ NBL(Keyboard SV03T_A84B SV3T Internal 13 Standard 83KS Black US International w/ Bulgaria acer P font power icon V0, NK.I1313.1L4, NK.I131S.0ER, NK.I1317.090)	6B.AB6N2.012
	UPPER CASE ASSY STEAM BLUE W/ NBL(Keyboard SV03T_A84B SV3T Internal 13 Standard 84KS Black UK acer P font power icon V0,NK.I1313.1LP,NK.I131S.0FA,NK.I1317.09K)	6B.AB6N2.013
	UPPER CASE ASSY STEAM BLUE W/ NBL(Keyboard SV03T_A84B SV3T Internal 13 Standard 84KS Black German acer P font power icon V0, NK.I1313.1LC, NK.I131S.0EZ, NK.I1317.098)	6B.AB6N2.014

CATEGORY	Acer Description	AcerPN
	UPPER CASE ASSY RED W/NBL(Keyboard SV03T_A84B SV3T Internal 13 Standard 83KS Black US International acer P font power icon V0,NK.I1313.1L1,NK.I131S.0EN,NK.I1317.08X)	TBD
	UPPER CASE ASSY RED W/NBL(Keyboard SV03T_A84B SV3T Internal 13 Standard 83KS Black Greek acer P font power icon V0,NK.I1313.1KV,NK.I131S.0EG,NK.I1317.08R)	TBD
	UPPER CASE ASSY RED W/NBL(Keyboard SV03T_A84B SV3T Internal 13 Standard 83KS Black Arabic acer P font power icon V0,NK.I1313.1KT,NK.I131S.0EE,NK.I1317.08P)	TBD
	UPPER CASE ASSY RED W/NBL(Keyboard SV03T_A84B SV3T Internal 13 Standard 83KS Black Traditional Chinese acer P font power icon V0,NK.I1313.1KU,NK.I131S.0EF,NK.I1317.08Q)	TBD
	UPPER CASE ASSY RED W/NBL(Keyboard SV03T_A84B SV3T Internal 13 Standard 83KS Black Russian acer P font power icon V0,NK.I1313.1KX,NK.I131S.0EJ,NK.I1317.08T)	TBD
	UPPER CASE ASSY RED W/NBL(Keyboard SV03T_A84B SV3T Internal 13 Standard 83KS Black US International w/ Hebrew acer P font power icon V0, NK.I1313.1L2, NK.I131S.0EP, NK.I1317.08Y)	TBD
	UPPER CASE ASSY RED W/NBL(Keyboard SV03T_A84B SV3T Internal 13 Standard 83KS Black Thailand acer P font power icon V0, NK.I1313.1L0,NK.I131S.0EM,NK.I1317.08W)	TBD
	UPPER CASE ASSY RED W/NBL(Keyboard SV03T_A84B SV3T Internal 13 Standard 83KS Black Korean acer P font power icon V0, NK.I1313.1KW,NK.I131S.0EH,NK.I1317.08S)	TBD
	UPPER CASE ASSY RED W/NBL(Keyboard SV03T_A84B SV3T Internal 13 Standard 83KS Black Ukrainian acer P font power icon V0, NK.I1313.1KY,NK.I131S.0EK,NK.I1317.08U)	TBD
	UPPER CASE ASSY RED W/NBL(Keyboard SV03T_A84B SV3T Internal 13 Standard 83KS Black Persian acer P font power icon V0, NK.I1313.1KZ,NK.I131S.0EL,NK.I1317.08V)	TBD

CATEGORY	Acer Description	AcerPN
	UPPER CASE ASSY SILVER W/BL(Keyboard SV03P_A84BWL SV3P Internal 13 Standard 83KS Black Thailand acer font White Backlit power icon V0 air inlet,NK.I1313.1K1)	TBD
	UPPER CASE ASSY SILVER W/BL(Keyboard SV03P_A84BWL SV3P Internal 13 Standard 83KS Black Greek acer font White Backlit power icon V0 air inlet,NK.I1313.1JW)	TBD
	UPPER CASE ASSY SILVER W/BL(Keyboard SV03P_A84BWL SV3P Internal 13 Standard 83KS Black Arabic acer font White Backlit power icon V0 air inlet,NK.I1313.1JU)	TBD
	UPPER CASE ASSY SILVER W/BL(Keyboard SV03P_A84BWL SV3P Internal 13 Standard 83KS Black Traditional Chinese acer font White Backlit power icon V0 air inlet,NK.I1313.1JV)	TBD
	UPPER CASE ASSY SILVER W/BL(Keyboard SV03P_A84BWL SV3P Internal 13 Standard 83KS Black Russian acer font White Backlit power icon V0 air inlet,NK.I1313.1JY)	TBD
	UPPER CASE ASSY SILVER W/BL(Keyboard SV03P_A84BWL SV3P Internal 13 Standard 83KS Black US International w/ Hebrew acer font White Backlit power icon V0 air inlet, NK.I1313.1K3)	TBD
	UPPER CASE ASSY SILVER W/BL(Keyboard SV03P_A84BWL SV3P Internal 13 Standard 83KS Black Thailand acer font White Backlit power icon V0 air inlet,NK.I1313.1K1)	TBD
	UPPER CASE ASSY SILVER W/BL(Keyboard SV03P_A84BWL SV3P Internal 13 Standard 83KS Black Korean acer font White Backlit power icon V0 air inlet,NK.I1313.1JX)	TBD
	UPPER CASE ASSY SILVER W/BL(Keyboard SV03P_A84BWL SV3P Internal 13 Standard 83KS Black Ukrainian acer font White Backlit power icon V0 air inlet,NK.I1313.1JZ)	TBD
	UPPER CASE ASSY SILVER W/BL(Keyboard SV03P_A84BWL SV3P Internal 13 Standard 83KS Black Persian acer font White Backlit power icon V0 air inlet,NK.I1313.1K0)	TBD
	UPPER CASE ASSY SILVER W/BL(Keyboard SV03P_A84BWL SV3P Internal 13 Standard 83KS Black US International w/ Canadian French acer font White Backlit power icon V0 air inlet,NK.I1313.1K4)	TBD

CATEGORY	Acer Description	AcerPN
	UPPER CASE ASSY ELECTRIC BLUE W/ BL(Keyboard SV03P_A84BWL SV3P Internal 13 Standard 83KS Black Greek acer font White Backlit power icon V0 air inlet,NK.I1313.1JW)	6B.ACPN2.001
	UPPER CASE ASSY ELECTRIC BLUE W/ BL(Keyboard SV03P_A84BWL SV3P Internal 13 Standard 83KS Black Arabic acer font White Backlit power icon V0 air inlet,NK.I1313.1JU)	6B.ACPN2.002
	UPPER CASE ASSY ELECTRIC BLUE W/ BL(Keyboard SV03P_A84BWL SV3P Internal 13 Standard 83KS Black Traditional Chinese acer font White Backlit power icon V0 air inlet, NK.I1313.1JV)	6B.ACPN2.003
	UPPER CASE ASSY ELECTRIC BLUE W/ BL(Keyboard SV03P_A84BWL SV3P Internal 13 Standard 83KS Black Russian acer font White Backlit power icon V0 air inlet, NK.I1313.1JY)	6B.ACPN2.004
	UPPER CASE ASSY ELECTRIC BLUE W/ BL(Keyboard SV03P_A84BWL SV3P Internal 13 Standard 83KS Black US International w/ Hebrew acer font White Backlit power icon V0 air inlet,NK.I1313.1K3)	6B.ACPN2.005
	UPPER CASE ASSY ELECTRIC BLUE W/ BL(Keyboard SV03P_A84BWL SV3P Internal 13 Standard 83KS Black Thailand acer font White Backlit power icon V0 air inlet, NK.I1313.1K1)	6B.ACPN2.032
	UPPER CASE ASSY ELECTRIC BLUE W/ BL(Keyboard SV03P_A84BWL SV3P Internal 13 Standard 83KS Black Korean acer font White Backlit power icon V0 air inlet,NK.I1313.1JX)	6B.ACPN2.006
	UPPER CASE ASSY ELECTRIC BLUE W/ BL(Keyboard SV03P_A84BWL SV3P Internal 13 Standard 83KS Black Ukrainian acer font White Backlit power icon V0 air inlet, NK.I1313.1JZ)	6B.ACPN2.007
	UPPER CASE ASSY ELECTRIC BLUE W/ BL(Keyboard SV03P_A84BWL SV3P Internal 13 Standard 83KS Black Persian acer font White Backlit power icon V0 air inlet,NK.I1313.1K0)	6B.ACPN2.008
	UPPER CASE ASSY ELECTRIC BLUE W/ BL(Keyboard SV03P_A84BWL SV3P Internal 13 Standard 83KS Black US International w/ Canadian French acer font White Backlit power icon V0 air inlet,NK.I1313.1K4)	6B.ACPN2.009



CATEGORY	Acer Description	AcerPN
	UPPER CASE ASSY ELECTRIC BLUE W/ BL(Keyboard SV03P_A84BWL SV3P Internal 13 Standard 87KS Black Japanese acer font White Backlit power icon V0 air inlet, NK.I1313.1KR)	6B.ACPN2.030
	UPPER CASE ASSY STEAM BLUE W/ BL(Keyboard SV03P_A84BWL SV3P Internal 13 Standard 83KS Black Thailand acer font White Backlit power icon V0 air inlet, NK.I1313.1K1)	6B.AB7N2.001
	UPPER CASE ASSY STEAM BLUE W/ BL(Keyboard SV03P_A84BWL SV3P Internal 13 Standard 83KS Black Greek acer font White Backlit power icon V0 air inlet,NK.I1313.1JW)	6B.AB7N2.002
	UPPER CASE ASSY STEAM BLUE W/ BL(Keyboard SV03P_A84BWL SV3P Internal 13 Standard 83KS Black Arabic acer font White Backlit power icon V0 air inlet,NK.I1313.1JU)	6B.AB7N2.003
	UPPER CASE ASSY STEAM BLUE W/ BL(Keyboard SV03P_A84BWL SV3P Internal 13 Standard 83KS Black Traditional Chinese acer font White Backlit power icon V0 air inlet, NK.I1313.1JV)	6B.AB7N2.004
	UPPER CASE ASSY STEAM BLUE W/ BL(Keyboard SV03P_A84BWL SV3P Internal 13 Standard 83KS Black Russian acer font White Backlit power icon V0 air inlet, NK.I1313.1JY)	6B.AB7N2.005
	UPPER CASE ASSY STEAM BLUE W/ BL(Keyboard SV03P_A84BWL SV3P Internal 13 Standard 83KS Black US International w/ Hebrew acer font White Backlit power icon V0 air inlet, NK.I1313.1K3)	6B.AB7N2.006
	UPPER CASE ASSY STEAM BLUE W/ BL(Keyboard SV03P_A84BWL SV3P Internal 13 Standard 83KS Black Thailand acer font White Backlit power icon V0 air inlet, NK.I1313.1K1)	6B.AB7N2.007
	UPPER CASE ASSY STEAM BLUE W/ BL(Keyboard SV03P_A84BWL SV3P Internal 13 Standard 83KS Black Korean acer font White Backlit power icon V0 air inlet,NK.I1313.1JX)	6B.AB7N2.008
	UPPER CASE ASSY STEAM BLUE W/ BL(Keyboard SV03P_A84BWL SV3P Internal 13 Standard 83KS Black Ukrainian acer font White Backlit power icon V0 air inlet, NK.I1313.1JZ)	6B.AB7N2.009



CATEGORY	Acer Description	AcerPN
	UPPER CASE ASSY RED W/BL(Keyboard SV03P_A84BWL SV3P Internal 13 Standard 83KS Black Korean acer font White Backlit power icon V0 air inlet,NK.I1313.1JX)	TBD
	UPPER CASE ASSY RED W/BL(Keyboard SV03P_A84BWL SV3P Internal 13 Standard 83KS Black Ukrainian acer font White Backlit power icon V0 air inlet,NK.I1313.1JZ)	TBD
	UPPER CASE ASSY RED W/BL(Keyboard SV03P_A84BWL SV3P Internal 13 Standard 83KS Black Persian acer font White Backlit power icon V0 air inlet,NK.I1313.1K0)	TBD
	UPPER CASE ASSY RED W/BL(Keyboard SV03P_A84BWL SV3P Internal 13 Standard 83KS Black US International w/ Canadian French acer font White Backlit power icon V0 air inlet,NK.I1313.1K4)	TBD
	UPPER CASE ASSY RED W/BL(Keyboard SV03P_A84BWL SV3P Internal 13 Standard 83KS Black US International w/ Bulgaria acer font White Backlit power icon V0 air inlet, NK.I1313.1K5)	TBD
	UPPER CASE ASSY RED W/BL(Keyboard SV03P_A84BWL SV3P Internal 13 Standard 84KS Black UK acer font White Backlit power icon V0 air inlet,NK.I1313.1KQ)	TBD
	UPPER CASE ASSY RED W/BL(Keyboard SV03P_A84BWL SV3P Internal 13 Standard 84KS Black German acer font White Backlit power icon V0 air inlet,NK.I1313.1KD)	TBD
	UPPER CASE ASSY RED W/BL(Keyboard SV03P_A84BWL SV3P Internal 13 Standard 84KS Black Swiss/G acer font White Backlit power icon V0 air inlet,NK.I1313.1KN)	TBD
	UPPER CASE ASSY RED W/BL(Keyboard SV03P_A84BWL SV3P Internal 13 Standard 84KS Black Belgium acer font White Backlit power icon V0 air inlet,NK.I1313.1K7)	TBD
	UPPER CASE ASSY RED W/BL(Keyboard SV03P_A84BWL SV3P Internal 13 Standard 84KS Black Danish acer font White Backlit power icon V0 air inlet,NK.I1313.1KA)	TBD
	UPPER CASE ASSY RED W/BL(Keyboard SV03P_A84BWL SV3P Internal 13 Standard 84KS Black Italian acer font White Backlit power icon V0 air inlet,NK.I1313.1KF)	TBD



CATEGORY	Acer Description	AcerPN
	UPPER CASE ASSY SILVER/SILVER KB W/ BL(Keyboard SV03P_A84SWL SV3P Internal 13 Standard 83KS Silver Korean acer font White Backlit power icon V0 air inlet,NK.I1313.1HZ)	6B.AB1N2.008
	UPPER CASE ASSY SILVER/SILVER KB W/ BL(Keyboard SV03P_A84SWL SV3P Internal 13 Standard 83KS Silver Ukrainian acer font White Backlit power icon V0 air inlet, NK.I1313.1J1)	6B.AB1N2.009
	UPPER CASE ASSY SILVER/SILVER KB W/ BL(Keyboard SV03P_A84SWL SV3P Internal 13 Standard 83KS Silver Persian acer font White Backlit power icon V0 air inlet,NK.I1313.1J2)	6B.AB1N2.010
	UPPER CASE ASSY SILVER/SILVER KB W/ BL(Keyboard SV03P_A84SWL SV3P Internal 13 Standard 83KS Silver US International w/ Canadian French acer font White Backlit power icon V0 air inlet,NK.I1313.1J6)	6B.AB1N2.011
	UPPER CASE ASSY SILVER/SILVER KB W/ BL(Keyboard SV03P_A84SWL SV3P Internal 13 Standard 83KS Silver US International w/ Bulgaria acer font White Backlit power icon V0 air inlet,NK.I1313.1J7)	6B.AB1N2.012
	UPPER CASE ASSY SILVER/SILVER KB W/ BL(Keyboard SV03P_A84SWL SV3P Internal 13 Standard 84KS Silver UK acer font White Backlit power icon V0 air inlet,NK.I1313.1JS)	6B.AB1N2.013
	UPPER CASE ASSY SILVER/SILVER KB W/ BL(Keyboard SV03P_A84SWL SV3P Internal 13 Standard 84KS Silver German acer font White Backlit power icon V0 air inlet, NK.I1313.1JF)	6B.AB1N2.014
	UPPER CASE ASSY SILVER/SILVER KB W/ BL(Keyboard SV03P_A84SWL SV3P Internal 13 Standard 84KS Silver Swiss/G acer font White Backlit power icon V0 air inlet, NK.I1313.1JQ)	6B.AB1N2.015
	UPPER CASE ASSY SILVER/SILVER KB W/ BL(Keyboard SV03P_A84SWL SV3P Internal 13 Standard 84KS Silver Belgium acer font White Backlit power icon V0 air inlet, NK.I1313.1J9)	6B.AB1N2.016
	UPPER CASE ASSY SILVER/SILVER KB W/ BL(Keyboard SV03P_A84SWL SV3P Internal 13 Standard 84KS Silver Danish acer font White Backlit power icon V0 air inlet,NK.I1313.1JC)	6B.AB1N2.017







CATEGORY	Acer Description	AcerPN
	UPPER CASE ASSY SILVER/SILVER KB W/ BL(Keyboard SV03P_A84SWL SV3P Internal 13 Standard 84KS Silver Italian acer font White Backlit power icon V0 air inlet,NK.I1313.1JH)	6B.AB1N2.018
	UPPER CASE ASSY SILVER/SILVER KB W/ BL(Keyboard SV03P_A84SWL SV3P Internal 13 Standard 84KS Silver French acer font White Backlit power icon V0 air inlet,NK.I1313.1JE)	6B.AB1N2.019
	UPPER CASE ASSY SILVER/SILVER KB W/ BL(Keyboard SV03P_A84SWL SV3P Internal 13 Standard 84KS Silver Hungarian acer font White Backlit power icon V0 air inlet, NK.I1313.1JG)	6B.AB1N2.020
	UPPER CASE ASSY SILVER/SILVER KB W/ BL(Keyboard SV03P_A84SWL SV3P Internal 13 Standard 84KS Silver Norwegian acer font White Backlit power icon V0 air inlet, NK.I1313.1JK)	6B.AB1N2.021
	UPPER CASE ASSY SILVER/SILVER KB W/ BL(Keyboard SV03P_A84SWL SV3P Internal 13 Standard 84KS Silver Portuguese acer font White Backlit power icon V0 air inlet, NK.I1313.1JL)	6B.AB1N2.022
	UPPER CASE ASSY SILVER/SILVER KB W/ BL(Keyboard SV03P_A84SWL SV3P Internal 13 Standard 84KS Silver Spanish acer font White Backlit power icon V0 air inlet, NK.I1313.1JN)	6B.AB1N2.023
	UPPER CASE ASSY SILVER/SILVER KB W/ BL(Keyboard SV03P_A84SWL SV3P Internal 13 Standard 84KS Silver Turkish acer font White Backlit power icon V0 air inlet,NK.I1313.1JR)	6B.AB1N2.024
	UPPER CASE ASSY SILVER/SILVER KB W/ BL(Keyboard SV03P_A84SWL SV3P Internal 13 Standard 84KS Silver Sweden acer font White Backlit power icon V0 air inlet, NK.I1313.1JP)	6B.AB1N2.025
	UPPER CASE ASSY SILVER/SILVER KB W/ BL(Keyboard SV03P_A84SWL SV3P Internal 13 Standard 84KS Silver FR/Arabic acer font White Backlit power icon V0 air inlet, NK.I1313.1JD)	6B.AB1N2.026
	UPPER CASE ASSY SILVER/SILVER KB W/ BL(Keyboard SV03P_A84SWL SV3P Internal 13 Standard 84KS Silver Nordic acer font White Backlit power icon V0 air inlet,NK.I1313.1JJ)	6B.AB1N2.027

CATEGORY	Acer Description	AcerPN
	UPPER CASE ASSY SILVER/SILVER KB W/ BL(Keyboard SV03P_A84SWL SV3P Internal 13 Standard 84KS Silver SLO/CRO acer font White Backlit power icon V0 air inlet, NK.I1313.1JM)	6B.AB1N2.028
	UPPER CASE ASSY SILVER/SILVER KB W/ BL(Keyboard SV03P_A84SWL SV3P Internal 13 Standard 84KS Silver CZ/SK acer font White Backlit power icon V0 air inlet, NK.I1313.1JB)	6B.AB1N2.029
	UPPER CASE ASSY SILVER/SILVER KB W/ BL(Keyboard SV03P_A84SWL SV3P Internal 13 Standard 84KS Silver Brazilian Portuguese acer font White Backlit power icon V0 air inlet, NK.I1313.1JA)	6B.AB1N2.030
	UPPER CASE ASSY SILVER/SILVER KB W/ BL(Keyboard SV03P_A84SWL SV3P Internal 13 Standard 84KS Silver ALA-Spanish acer font White Backlit power icon V0 air inlet, NK.I1313.1J8)	6B.AB1N2.031
	UPPER CASE ASSY SILVER/SILVER KB W/ BL(Keyboard SV03P_A84SWL SV3P Internal 13 Standard 87KS Silver Japanese acer font White Backlit power icon V0 air inlet, NK.I1313.1JT)	6B.AB1N2.032
<b>MAINBOARD</b>		
	Mainboard	TBD
<b>POINT DEVICE</b>		
	TOUCHPAD ASSY SILVER-SYNAPTICS	56.AB2N2.001
	TOUCHPAD ASSY ELECTRIC BLUE-SYNAPTICS	56.ACQN2.001
	TOUCHPAD ASSY STEAM BLUE-SYNAPTICS	56.AB6N2.001
	TOUCHPAD ASSY RED-SYNAPTICS	TBD
	TOUCHPAD ASSY SILVER-ELANTECH	56.AB2N2.002
	TOUCHPAD ASSY ELECTRIC BLUE-ELANTECH	56.ACQN2.002
	TOUCHPAD ASSY STEAM BLUE-ELANTECH	56.AB6N2.002
TOUCHPAD ASSY RED-ELANTECH	TBD	

CATEGORY	Acer Description	AcerPN
<b>SPEAKER</b>		
	SPEAKER L	23.AB2N2.002
	SPEAKER R	23.AB2N2.003
<b>MISCELLANEOUS</b>		
	BATT_ACETATE_TAPE	47.Q7KN2.007
	LCD PANEL ADHESIVE	47.AB2N2.001
	LCD ALIGNMENT MYLAR	47.Q55N2.002

# Screw List

Table 6-5. Screw List

CATEGORY	Acer Description	Acer PN
<b>SCREWS</b>		
	SCREW 2.0D 2.5L K 5D 0.5T NI NL	86.H14N2.001
	SCREW 2.5D 2.5L K 8D 0.6T ZK NL	86.H14N2.002
	SCREW 2.5D 5.0L K 4.6D NI NL	86.H14N2.003
	SCREW M M 2.0D 4.0L K 4.6D BNI NL	86.Q99N2.001
	SCREW 2D 0.7+3L K 5.0D 0.8T ZK NL	86.AB2N2.001
	SCREW 2.0D 5.5L K 4.0D 0.8T O NL	86.AB2N2.002