

# Exploded Diagram

## Main Assembly

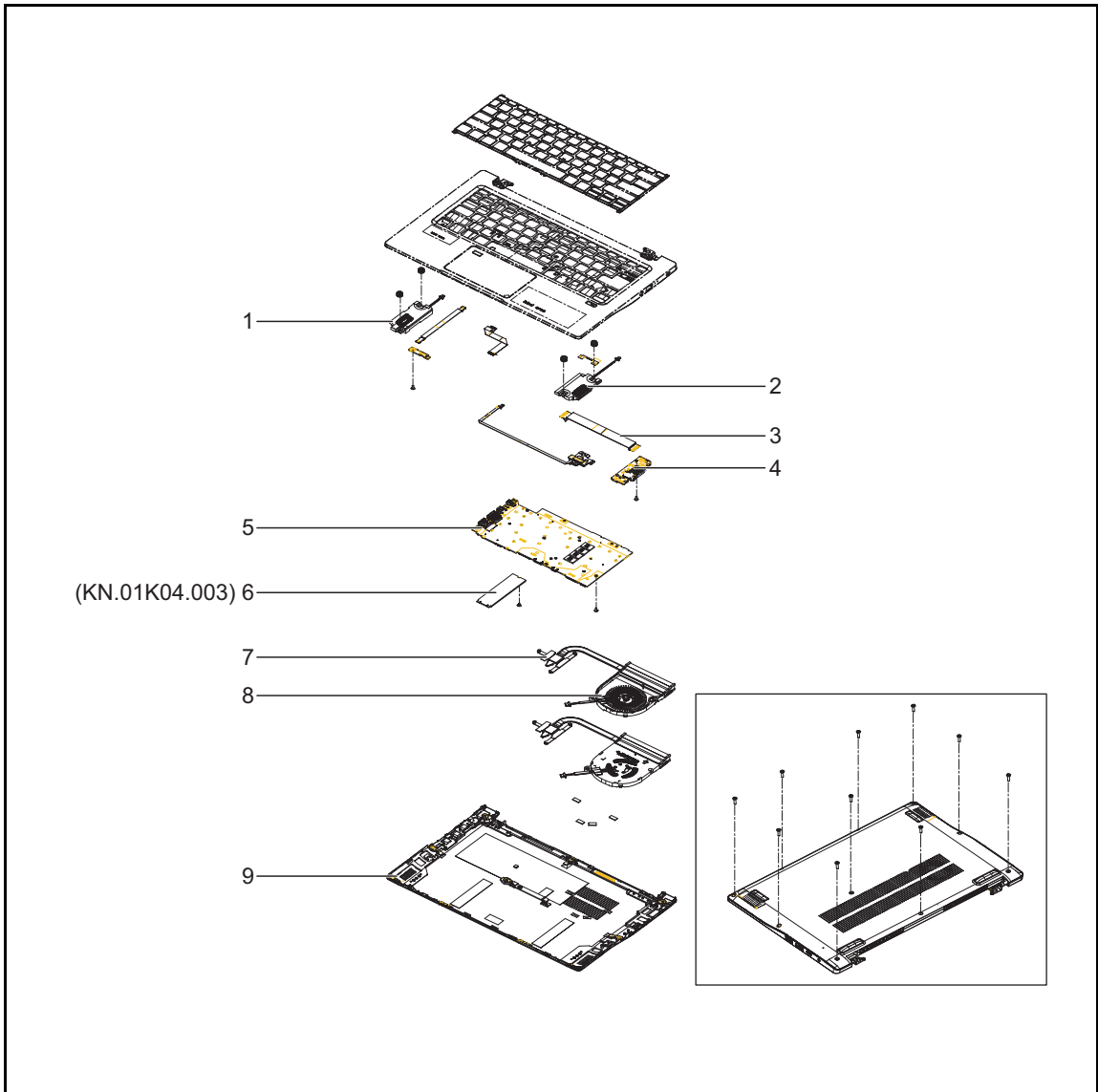

**Figure 6-1. Main Assembly Exploded Diagram**

**Table 6-1. Main Assembly Exploded Diagram**

No.	Description	P/N
1	SPEAKER L	23.HSFN2.002
2	SPEAKER R	23.HSFN2.003
3	FFC CABLE FOR IO BOARD	50.HSEN2.001
4	IO BOARD	55.A0NN2.001

**Table 6-1. Main Assembly Exploded Diagram**

<b>No.</b>	<b>Description</b>	<b>P/N</b>
5	Mainboard SF314-59 Intel Ci31115G4 8GB UMA	NB.A0P11.001
6	Flash Disk MICRON SSD NAND 1024GB M.2 2280 2210 MTFDHBA1T0QFD-1AX15ABYY LF+HF	KN.01K04.003
7	THERMAL MODULE UMA W/O FAN	24.A0NN2.001
8	FAN	23.HSFN2.001
9	LOWER CASE ASSY - SILVER	60.HSFN2.001

# Upper Cover Assembly

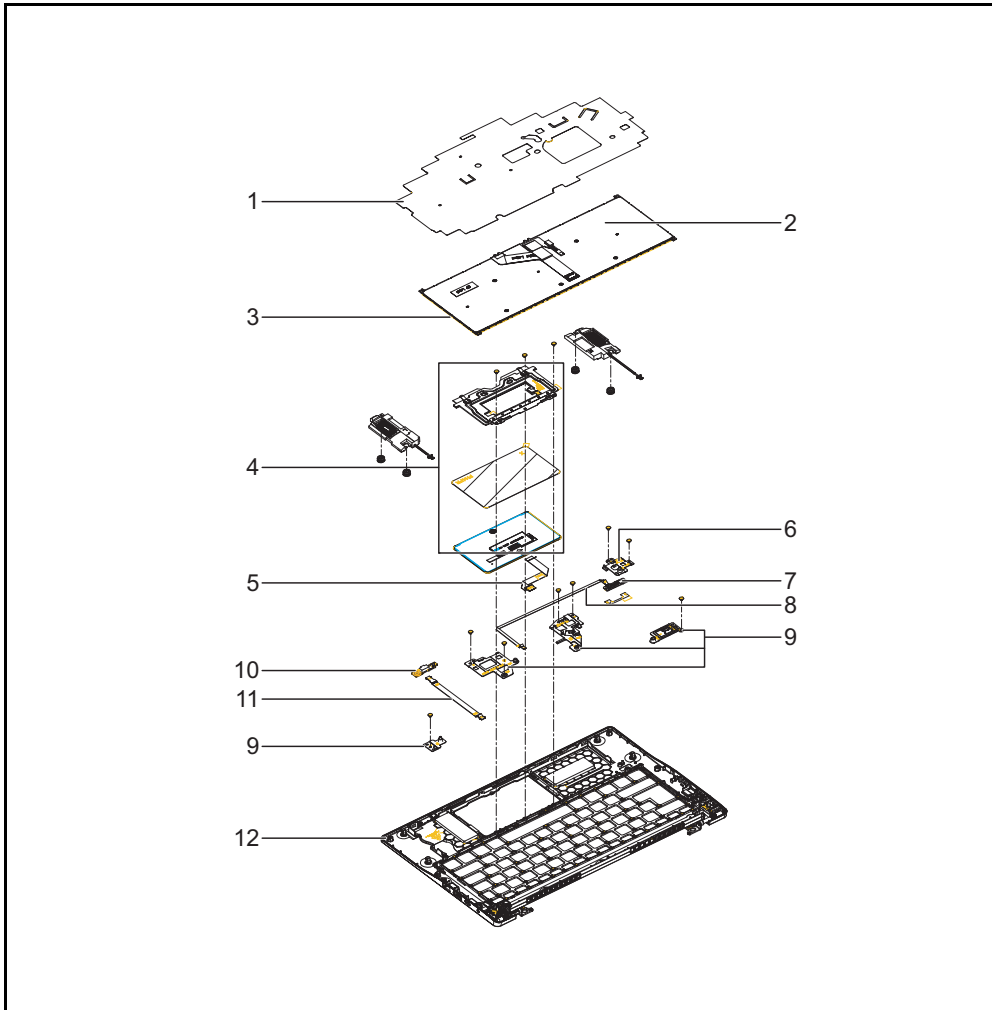

**Figure 6-2. Upper Cover Assembly Exploded Diagram**

**Table 6-2. Upper Cover Assembly Exploded Diagram**

No.	Description	P/N
1	Mylar	N/A
2	Keyboard Backlight	N/A
3	Phantom KB CHICONY SV03P_A70BWL SV3P Internal 13 Standard Black acer font, ODM adhesive White BL power icon, V0	NK.I1313.0QM
4	TOUCHPAD ASSY SILVER-ELANTECH	56.HSFN2.001
5	FFC CABLE FOR TP	50.HSEN2.004
6	FINGERPRINT BRACKET	33.HSFN2.006
7	FP BOARD	55.HSEN2.003
8	FFC CABLE FOR FP	50.HSEN2.003

**Table 6-2. Upper Cover Assembly Exploded Diagram**

<b>No.</b>	<b>Description</b>	<b>P/N</b>
9	UPPER CASE SUPPORT BRACKET A	33.HSFN2.002
	UPPER CASE SUPPORT BRACKET B	33.HSFN2.003
	UPPER CASE SUPPORT BRACKET C	33.HSFN2.004
	UPPER CASE SUPPORT BRACKET D	33.HSFN2.005
10	HALL SENSOR BOARD	55.HSEN2.002
11	FFC CABLE FOR SENSOR BOARD	50.HSEN2.002
12	UPPER CASE ASSY SILVER/SILVER W/BL(Keyboard CHICONY SV03P_A70SWL SV3P Internal 13 Standard 83KS Silver US International acer legend, power icon, White BL Meida V0,NK.I1313.0WN)	6B.A0MN2.001

# LCD Assembly

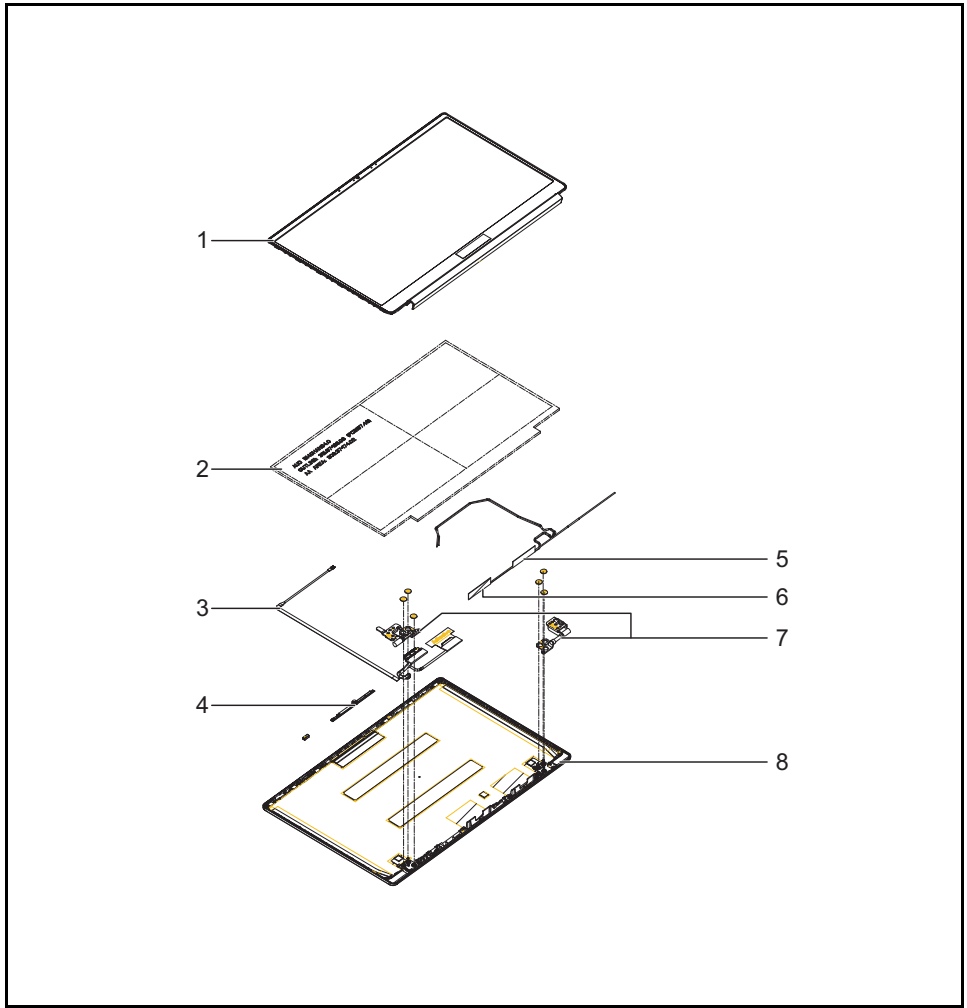

**Figure 6-3. LCD Assembly Exploded Diagram**

**Table 6-3. LCD Assembly Exploded Diagram**

No.	Description	P/N
1	LCD BEZEL BLACK	60.HSFN2.004
2	LED LCD Panel CMI 14" FHD None Glare N140HCE-EN2 LF 300nit 25ms 700:1 (eDP, IPS, narrow border, 2.4mm Max)	KL.1400D.024
3	LCD EDP CABLE	50.HSFN2.003
4	Camera CHICONY HD Camera CH_GC1009_RTS5846N_Powertip_ZTS6735_Windows Y3.2mm (dual Mic distance 66mm)	KS.0HD06.019
5	ANTENNA - MAIN	50.HSFN2.001
6	ANTENNA - AUX	50.HSFN2.002



**Table 6-3. LCD Assembly Exploded Diagram**

<b>No.</b>	<b>Description</b>	<b>P/N</b>
7	LCD HINGE R&L	33.HSFN2.001
8	LCD COVER ASSY - SILVER FOR 3.0mm PANEL	60.HSFN2.002

# FRU List

**Table 6-4. FRU List**

CATEGORY	Acer Description	AcerPN
<b>BOARD</b>		
	IO BOARD	55.A0NN2.001
	HALL SENSOR BOARD	55.HSEN2.002
	FP BOARD	55.HSEN2.003
<b>CABLE</b>		
	FFC CABLE FOR IO BOARD	50.HSEN2.001
	FFC CABLE FOR SENSOR BOARD	50.HSEN2.002
	FFC CABLE FOR FP	50.HSEN2.003
	FFC CABLE FOR TP	50.HSEN2.004
	ANTENNA - MAIN	50.HSFN2.001
	ANTENNA - AUX	50.HSFN2.002
	LCD EDP CABLE	50.HSFN2.003
	LCD EDP CABLE FOR N14FHDSSRIB	50.A0NN2.001
	POWER CORD 1M BLACK SOUTH AFRICA - NEW	27.HEEN2.001
	POWER CORD 1M BLACK BLACK AUSTRALIA	27.Q28N2.002

CATEGORY	Acer Description	AcerPN
	POWER CORD 1M BLACK EU	27.Q28N2.003
	POWER CORD 1M BLACK EU(New source)	27.Q7DN2.001
	POWER CORD 1M BLACK DENMARK	27.Q28N2.004
	POWER CORD 1M BLACK ISRAEL	27.Q28N2.005
	POWER CORD 1M BLACK ITALIAN	27.Q28N2.006
	POWER CORD 1M BLACK JAPAN	27.Q28N2.007
	POWER CORD 1M BLACK CHINA - NEW	27.HEEN2.002
	POWER CORD 1M BLACK INDIA	27.Q28N2.009
	POWER CORD 1M BLACK SWISS	27.Q28N2.010
	POWER CORD 1M BLACK UK	27.Q28N2.011
	POWER CORD 1M BLACK UK(New source)	27.Q7DN2.002
	POWER CORD 1M BLACK TWN	27.Q28N2.012
	POWER CORD 1M BLACK ARGENTINA - NEW	27.HEEN2.003
	POWER CORD 1M BLACK KOREA	27.Q28N2.014
	POWER CORD 1M BLACK US	27.Q28N2.015
	POWER CORD 1M BLACK US(New source)	27.Q7DN2.003
	POWER CORD 1M BLACK BRAZIL	27.Q28N2.016
<b>CASE/COVER/BRACKET ASSEMBLY</b>		
	LOWER CASE ASSY - SILVER	60.HSFN2.001
	LOWER CASE ASSY - PINK	60.A0SN2.001
	LOWER CASE ASSY - BLUE	60.A0QN2.001
	LCD COVER ASSY - SILVER FOR 3.0mm PANEL	60.HSFN2.002
	LCD COVER ASSY - SILVER FOR 2.4mm PANEL	60.HSFN2.003
	LCD COVER ASSY - SILVER FOR 2.1mm PANEL	60.A0NN2.001
	LCD COVER ASSY - PINK FOR 3.0mm PANEL	60.A0SN2.002
	LCD COVER ASSY - PINK FOR 2.4mm PANEL	60.A0SN2.003
	LCD COVER ASSY - PINK FOR 2.1mm PANEL	60.A0SN2.004
	LCD COVER ASSY - BLUE FOR 3.0mm PANEL	60.A0QN2.002
	LCD COVER ASSY - BLUE FOR 2.4mm PANEL	60.A0QN2.003



CATEGORY	Acer Description	AcerPN
	LCD COVER ASSY - BLUE FOR 2.1mm PANEL	60.A0QN2.004
	LCD BEZEL BLACK	60.HSFN2.004
	LCD BEZEL PINK	60.A0SN2.005
	LCD BEZEL BLUE	60.A0QN2.005
	LCD HINGE R&L	33.HSFN2.001
	UPPER CASE SUPPORT BRACKET A	33.HSFN2.002
	UPPER CASE SUPPORT BRACKET B	33.HSFN2.003
	UPPER CASE SUPPORT BRACKET C	33.HSFN2.004
	UPPER CASE SUPPORT BRACKET D	33.HSFN2.005
	FINGERPRINT BRACKET	33.HSFN2.006
<b>FAN</b>		
	FAN	23.HSFN2.001
<b>HEATSINK</b>		
	THERMAL MODULE UMA W/O FAN	24.A0NN2.001
<b>KB ASSEMBLY</b>		
	UPPER CASE ASSY SILVER/SILVER W/ BL(Keyboard CHICONY SV03P_A70SWL SV3P Internal 13 Standard 83KS Silver US International acer legend, power icon, White BL Meida V0,NK.I1313.0WN)	6B.A0MN2.001
	UPPER CASE ASSY SILVER/SILVER W/ BL(Keyboard CHICONY SV03P_A70SWL SV3P Internal 13 Standard 83KS Silver Greek acer legend, power icon, White BL Meida V0,NK.I1313.0WG)	6B.A0MN2.002

CATEGORY	Acer Description	AcerPN
	UPPER CASE ASSY SILVER/SILVER W/ BL(Keyboard CHICONY SV03P_A70SWL SV3P Internal 13 Standard 83KS Silver Arabic acer legend, power icon, White BL Meida V0,NK.I1313.0WE)	6B.A0MN2.003
	UPPER CASE ASSY SILVER/SILVER W/ BL(Keyboard CHICONY SV03P_A70SWL SV3P Internal 13 Standard 83KS Silver Traditional Chinese acer legend, power icon, White BL Meida V0,NK.I1313.0WF)	6B.A0MN2.004
	UPPER CASE ASSY SILVER/SILVER W/ BL(Keyboard CHICONY SV03P_A70SWL SV3P Internal 13 Standard 83KS Silver Russian acer legend, power icon, White BL Meida V0,NK.I1313.0WJ)	6B.A0MN2.005
	UPPER CASE ASSY SILVER/SILVER W/ BL(Keyboard CHICONY SV03P_A70SWL SV3P Internal 13 Standard 83KS Silver US International w/ Hebrew acer legend, power icon, White BL Meida V0,NK.I1313.0WP)	6B.A0MN2.006
	UPPER CASE ASSY SILVER/SILVER W/ BL(Keyboard CHICONY SV03P_A70SWL SV3P Internal 13 Standard 83KS Silver Thailand acer legend, power icon, White BL Meida V0,NK.I1313.0WM)	6B.A0MN2.007
	UPPER CASE ASSY SILVER/SILVER W/ BL(Keyboard CHICONY SV03P_A70SWL SV3P Internal 13 Standard 83KS Silver Korean acer legend, power icon, White BL Meida V0,NK.I1313.0WH)	6B.A0MN2.008
	UPPER CASE ASSY SILVER/SILVER W/ BL(Keyboard CHICONY SV03P_A70SWL SV3P Internal 13 Standard 83KS Silver Ukrainian acer legend, power icon, White BL Meida V0,NK.I1313.0WK)	6B.A0MN2.009
	UPPER CASE ASSY SILVER/SILVER W/ BL(Keyboard CHICONY SV03P_A70SWL SV3P Internal 13 Standard 83KS Silver Persian acer legend, power icon, White BL Meida V0,NK.I1313.0WL)	6B.A0MN2.010
	UPPER CASE ASSY SILVER/SILVER W/ BL(Keyboard CHICONY SV03P_A70SWL SV3P Internal 13 Standard 83KS Silver US International w/ Canadian French acer legend, power icon, White BL Meida V0,NK.I1313.0WQ)	6B.A0MN2.011

CATEGORY	Acer Description	AcerPN
	UPPER CASE ASSY SILVER/BLACK NBL(Keyboard CHICONY SV03T_A70B SV3T Internal 13 Standard 83KS Black Korean acer legend, power icon, Meida V0,NK.I1313.0RQ)	6B.A0NN2.008
	UPPER CASE ASSY SILVER/BLACK NBL(Keyboard CHICONY SV03T_A70B SV3T Internal 13 Standard 83KS Black Ukrainian acer legend, power icon, Meida V0,NK.I1313.0RS)	6B.A0NN2.009
	UPPER CASE ASSY SILVER/BLACK NBL(Keyboard CHICONY SV03T_A70B SV3T Internal 13 Standard 83KS Black Persian acer legend, power icon, Meida V0,NK.I1313.0RT)	6B.A0NN2.010
	UPPER CASE ASSY SILVER/BLACK NBL(Keyboard CHICONY SV03T_A70B SV3T Internal 13 Standard 83KS Black US International w/ Canadian French acer legend, power icon, Meida V0,NK.I1313.0RX)	6B.A0NN2.011
	UPPER CASE ASSY SILVER/BLACK NBL(Keyboard CHICONY SV03T_A70B SV3T Internal 13 Standard 83KS Black US International w/ Bulgaria acer legend, power icon, Meida V0,NK.I1313.0RY)	6B.A0NN2.012
	UPPER CASE ASSY SILVER/BLACK NBL(Keyboard CHICONY SV03T_A70B SV3T Internal 13 Standard 84KS Black UK acer legend, power icon, Meida V0,NK.I1313.0SH)	6B.A0NN2.013
	UPPER CASE ASSY SILVER/BLACK NBL(Keyboard CHICONY SV03T_A70B SV3T Internal 13 Standard 84KS Black German acer legend, power icon, Meida V0,NK.I1313.0S6)	6B.A0NN2.014
	UPPER CASE ASSY SILVER/BLACK NBL(Keyboard CHICONY SV03T_A70B SV3T Internal 13 Standard 84KS Black Swiss/G acer legend, power icon, Meida V0,NK.I1313.0SF)	6B.A0NN2.015
	UPPER CASE ASSY SILVER/BLACK NBL(Keyboard CHICONY SV03T_A70B SV3T Internal 13 Standard 84KS Black Belgium acer legend, power icon, Meida V0,NK.I1313.0S0)	6B.A0NN2.016
	UPPER CASE ASSY SILVER/BLACK NBL(Keyboard CHICONY SV03T_A70B SV3T Internal 13 Standard 84KS Black Danish acer legend, power icon, Meida V0,NK.I1313.0S3)	6B.A0NN2.017
UPPER CASE ASSY SILVER/BLACK NBL(Keyboard CHICONY SV03T_A70B SV3T Internal 13 Standard 84KS Black Italian acer legend, power icon, Meida V0,NK.I1313.0S8)	6B.A0NN2.018	

CATEGORY	Acer Description	AcerPN
	UPPER CASE ASSY PINK/BLACK W/BL (Keyboard CHICONY SV03P_A70BWL SV3P Internal 13 Standard 83KS Black Thailand acer legend power icon, White BL, Media, V0,NK.I1313.0TQ)	6B.A0RN2.007
	UPPER CASE ASSY PINK/BLACK W/BL (Keyboard CHICONY SV03P_A70BWL SV3P Internal 13 Standard 83KS Black Korean acer legend power icon, White BL, Media, V0,NK.I1313.0TL)	6B.A0RN2.008
	UPPER CASE ASSY PINK/BLACK W/BL (Keyboard CHICONY SV03P_A70BWL SV3P Internal 13 Standard 83KS Black Ukrainian acer legend power icon, White BL, Media, V0,NK.I1313.0TN)	6B.A0RN2.009
	UPPER CASE ASSY PINK/BLACK W/BL (Keyboard CHICONY SV03P_A70BWL SV3P Internal 13 Standard 83KS Black Persian acer legend power icon, White BL, Media, V0,NK.I1313.0TP)	6B.A0RN2.010
	UPPER CASE ASSY PINK/BLACK W/BL (Keyboard CHICONY SV03P_A70BWL SV3P Internal 13 Standard 83KS Black US International w/ Canadian French acer legend power icon, White BL, Media, V0,NK.I1313.0TT)	6B.A0RN2.011
	UPPER CASE ASSY PINK/BLACK W/BL (Keyboard CHICONY SV03P_A70BWL SV3P Internal 13 Standard 83KS Black US International w/ Bulgaria acer legend power icon, White BL, Media, V0,NK.I1313.0TU)	6B.A0RN2.012
	UPPER CASE ASSY PINK/BLACK W/BL (Keyboard CHICONY SV03P_A70BWL SV3P Internal 13 Standard 84KS Black UK acer legend power icon, White BL, Media, V0,NK.I1313.0UD)	6B.A0RN2.013
	UPPER CASE ASSY PINK/BLACK W/BL (Keyboard CHICONY SV03P_A70BWL SV3P Internal 13 Standard 84KS Black German acer legend power icon, White BL, Media, V0,NK.I1313.0U2)	6B.A0RN2.014
	UPPER CASE ASSY PINK/BLACK W/BL (Keyboard CHICONY SV03P_A70BWL SV3P Internal 13 Standard 84KS Black Swiss/G acer legend power icon, White BL, Media, V0,NK.I1313.0UB)	6B.A0RN2.015

CATEGORY	Acer Description	AcerPN
	UPPER CASE ASSY PINK/BLACK NBL(Keyboard CHICONY SV03T_A70B SV3T Internal 13 Standard 83KS Black Greek acer legend, power icon, Meida V0,NK.I1313.0RP)	6B.A0RN2.034
	UPPER CASE ASSY PINK/BLACK NBL(Keyboard CHICONY SV03T_A70B SV3T Internal 13 Standard 83KS Black Arabic acer legend, power icon, Meida V0,NK.I1313.0RM)	6B.A0RN2.035
	UPPER CASE ASSY PINK/BLACK NBL(Keyboard CHICONY SV03T_A70B SV3T Internal 13 Standard 83KS Black Traditional Chinese acer legend, power icon, Meida V0,NK.I1313.0RN)	6B.A0RN2.036
	UPPER CASE ASSY PINK/BLACK NBL(Keyboard CHICONY SV03T_A70B SV3T Internal 13 Standard 83KS Black Russian acer legend, power icon, Meida V0,NK.I1313.0RR)	6B.A0SN2.001
	UPPER CASE ASSY PINK/BLACK NBL(Keyboard CHICONY SV03T_A70B SV3T Internal 13 Standard 83KS Black US International w/ Hebrew acer legend, power icon, Meida V0,NK.I1313.0RW)	6B.A0SN2.002
	UPPER CASE ASSY PINK/BLACK NBL(Keyboard CHICONY SV03T_A70B SV3T Internal 13 Standard 83KS Black Thailand acer legend, power icon, Meida V0,NK.I1313.0RU)	6B.A0SN2.003
	UPPER CASE ASSY PINK/BLACK NBL(Keyboard CHICONY SV03T_A70B SV3T Internal 13 Standard 83KS Black Korean acer legend, power icon, Meida V0,NK.I1313.0RQ)	6B.A0SN2.004
	UPPER CASE ASSY PINK/BLACK NBL(Keyboard CHICONY SV03T_A70B SV3T Internal 13 Standard 83KS Black Ukrainian acer legend, power icon, Meida V0,NK.I1313.0RS)	6B.A0SN2.005
	UPPER CASE ASSY PINK/BLACK NBL(Keyboard CHICONY SV03T_A70B SV3T Internal 13 Standard 83KS Black Persian acer legend, power icon, Meida V0,NK.I1313.0RT)	6B.A0SN2.006
	UPPER CASE ASSY PINK/BLACK NBL(Keyboard CHICONY SV03T_A70B SV3T Internal 13 Standard 83KS Black US International w/ Canadian French acer legend, power icon, Meida V0,NK.I1313.0RX)	6B.A0SN2.007

CATEGORY	Acer Description	AcerPN
	UPPER CASE ASSY BLUE/BLACK W/BL (Keyboard CHICONY SV03P_A70BWL SV3P Internal 13 Standard 83KS Black US International acer legend power icon, White BL, Media, V0,NK.I1313.0TR)	6B.A0PN2.001
	UPPER CASE ASSY BLUE/BLACK W/BL (Keyboard CHICONY SV03P_A70BWL SV3P Internal 13 Standard 83KS Black Greek acer legend power icon, White BL, Media, V0,NK.I1313.0TK)	6B.A0PN2.002
	UPPER CASE ASSY BLUE/BLACK W/BL (Keyboard CHICONY SV03P_A70BWL SV3P Internal 13 Standard 83KS Black Arabic acer legend power icon, White BL, Media, V0,NK.I1313.0TH)	6B.A0PN2.003
	UPPER CASE ASSY BLUE/BLACK W/BL (Keyboard CHICONY SV03P_A70BWL SV3P Internal 13 Standard 83KS Black Traditional Chinese acer legend power icon, White BL, Media, V0,NK.I1313.0TJ)	6B.A0PN2.004
	UPPER CASE ASSY BLUE/BLACK W/BL (Keyboard CHICONY SV03P_A70BWL SV3P Internal 13 Standard 83KS Black Russian acer legend power icon, White BL, Media, V0,NK.I1313.0TM)	6B.A0PN2.005
	UPPER CASE ASSY BLUE/BLACK W/BL (Keyboard CHICONY SV03P_A70BWL SV3P Internal 13 Standard 83KS Black US International w/ Hebrew acer legend power icon, White BL, Media, V0,NK.I1313.0TS)	6B.A0PN2.006
	UPPER CASE ASSY BLUE/BLACK W/BL (Keyboard CHICONY SV03P_A70BWL SV3P Internal 13 Standard 83KS Black Thailand acer legend power icon, White BL, Media, V0,NK.I1313.0TQ)	6B.A0PN2.007
	UPPER CASE ASSY BLUE/BLACK W/BL (Keyboard CHICONY SV03P_A70BWL SV3P Internal 13 Standard 83KS Black Korean acer legend power icon, White BL, Media, V0,NK.I1313.0TL)	6B.A0PN2.008
	UPPER CASE ASSY BLUE/BLACK W/BL (Keyboard CHICONY SV03P_A70BWL SV3P Internal 13 Standard 83KS Black Ukrainian acer legend power icon, White BL, Media, V0,NK.I1313.0TN)	6B.A0PN2.009

CATEGORY	Acer Description	AcerPN
	UPPER CASE ASSY BLUE/BLACK NBL(Keyboard CHICONY SV03T_A70B SV3T Internal 13 Standard 83KS Black US International w/ Hebrew acer legend, power icon, Meida V0,NK.I1313.0RW)	6B.A0QN2.006
	UPPER CASE ASSY BLUE/BLACK NBL(Keyboard CHICONY SV03T_A70B SV3T Internal 13 Standard 83KS Black Thailand acer legend, power icon, Meida V0,NK.I1313.0RU)	6B.A0QN2.007
	UPPER CASE ASSY BLUE/BLACK NBL(Keyboard CHICONY SV03T_A70B SV3T Internal 13 Standard 83KS Black Korean acer legend, power icon, Meida V0,NK.I1313.0RQ)	6B.A0QN2.008
	UPPER CASE ASSY BLUE/BLACK NBL(Keyboard CHICONY SV03T_A70B SV3T Internal 13 Standard 83KS Black Ukrainian acer legend, power icon, Meida V0,NK.I1313.0RS)	6B.A0QN2.009
	UPPER CASE ASSY BLUE/BLACK NBL(Keyboard CHICONY SV03T_A70B SV3T Internal 13 Standard 83KS Black Persian acer legend, power icon, Meida V0,NK.I1313.0RT)	6B.A0QN2.010
	UPPER CASE ASSY BLUE/BLACK NBL(Keyboard CHICONY SV03T_A70B SV3T Internal 13 Standard 83KS Black US International w/ Canadian French acer legend, power icon, Meida V0,NK.I1313.0RX)	6B.A0QN2.011
	UPPER CASE ASSY BLUE/BLACK NBL(Keyboard CHICONY SV03T_A70B SV3T Internal 13 Standard 83KS Black US International w/ Bulgaria acer legend, power icon, Meida V0,NK.I1313.0RY)	6B.A0QN2.012
	UPPER CASE ASSY BLUE/BLACK NBL(Keyboard CHICONY SV03T_A70B SV3T Internal 13 Standard 84KS Black UK acer legend, power icon, Meida V0,NK.I1313.0SH)	6B.A0QN2.013
	UPPER CASE ASSY BLUE/BLACK NBL(Keyboard CHICONY SV03T_A70B SV3T Internal 13 Standard 84KS Black German acer legend, power icon, Meida V0,NK.I1313.0S6)	6B.A0QN2.014
UPPER CASE ASSY BLUE/BLACK NBL(Keyboard CHICONY SV03T_A70B SV3T Internal 13 Standard 84KS Black Swiss/G acer legend, power icon, Meida V0,NK.I1313.0SF)	6B.A0QN2.015	

CATEGORY	Acer Description	AcerPN
	UPPER CASE ASSY BLUE/BLACK NBL(Keyboard CHICONY SV03T_A70B SV3T Internal 13 Standard 84KS Black Belgium acer legend, power icon, Meida V0,NK.I1313.0S0)	6B.A0QN2.016
	UPPER CASE ASSY BLUE/BLACK NBL(Keyboard CHICONY SV03T_A70B SV3T Internal 13 Standard 84KS Black Danish acer legend, power icon, Meida V0,NK.I1313.0S3)	6B.A0QN2.017
	UPPER CASE ASSY BLUE/BLACK NBL(Keyboard CHICONY SV03T_A70B SV3T Internal 13 Standard 84KS Black Italian acer legend, power icon, Meida V0,NK.I1313.0S8)	6B.A0QN2.018
	UPPER CASE ASSY BLUE/BLACK NBL(Keyboard CHICONY SV03T_A70B SV3T Internal 13 Standard 84KS Black French acer legend, power icon, Meida V0,NK.I1313.0S5)	6B.A0QN2.019
	UPPER CASE ASSY BLUE/BLACK NBL(Keyboard CHICONY SV03T_A70B SV3T Internal 13 Standard 84KS Black Hungarian acer legend, power icon, Meida V0,NK.I1313.0S7)	6B.A0QN2.020
	UPPER CASE ASSY BLUE/BLACK NBL(Keyboard CHICONY SV03T_A70B SV3T Internal 13 Standard 84KS Black Norwegian acer legend, power icon, Meida V0,NK.I1313.0SA)	6B.A0QN2.021
	UPPER CASE ASSY BLUE/BLACK NBL(Keyboard CHICONY SV03T_A70B SV3T Internal 13 Standard 84KS Black Portuguese acer legend, power icon, Meida V0,NK.I1313.0SB)	6B.A0QN2.022
	UPPER CASE ASSY BLUE/BLACK NBL(Keyboard CHICONY SV03T_A70B SV3T Internal 13 Standard 84KS Black Spanish acer legend, power icon, Meida V0,NK.I1313.0SD)	6B.A0QN2.023
	UPPER CASE ASSY BLUE/BLACK NBL(Keyboard CHICONY SV03T_A70B SV3T Internal 13 Standard 84KS Black Turkish acer legend, power icon, Meida V0,NK.I1313.0SG)	6B.A0QN2.024
	UPPER CASE ASSY BLUE/BLACK NBL(Keyboard CHICONY SV03T_A70B SV3T Internal 13 Standard 84KS Black Sweden acer legend, power icon, Meida V0,NK.I1313.0SE)	6B.A0QN2.025
UPPER CASE ASSY BLUE/BLACK NBL(Keyboard CHICONY SV03T_A70B SV3T Internal 13 Standard 84KS Black FR/Arabic acer legend, power icon, Meida V0,NK.I1313.0S4)	6B.A0QN2.026	







CATEGORY	Acer Description	AcerPN
	UPPER CASE ASSY BLUE/BLACK NBL(Keyboard CHICONY SV03T_A70B SV3T Internal 13 Standard 84KS Black Nordic acer legend, power icon, Meida V0,NK.I1313.0S9)	6B.A0QN2.027
	UPPER CASE ASSY BLUE/BLACK NBL(Keyboard CHICONY SV03T_A70B SV3T Internal 13 Standard 84KS Black SLO/CRO acer legend, power icon, Meida V0,NK.I1313.0SC)	6B.A0QN2.028
	UPPER CASE ASSY BLUE/BLACK NBL(Keyboard CHICONY SV03T_A70B SV3T Internal 13 Standard 84KS Black CZ/SK acer legend, power icon, Meida V0,NK.I1313.0S2)	6B.A0QN2.029
	UPPER CASE ASSY BLUE/BLACK NBL(Keyboard CHICONY SV03T_A70B SV3T Internal 13 Standard 84KS Black Brazilian Portuguese acer legend, power icon, Meida V0,NK.I1313.0S1)	6B.A0QN2.030
	UPPER CASE ASSY BLUE/BLACK NBL(Keyboard CHICONY SV03T_A70B SV3T Internal 13 Standard 84KS Black ALA-Spanish acer legend, power icon, Meida V0,NK.I1313.0RZ)	6B.A0QN2.031
	UPPER CASE ASSY BLUE/BLACK NBL(Keyboard CHICONY SV03T_A70B SV3T Internal 13 Standard 87KS Black Japanese acer legend, power icon, Meida V0,NK.I1313.0SJ)	6B.A0QN2.032
<b>MAINBOARD</b>		
	Mainboard SF314-59 Intel Ci31115G4 8GB UMA	NB.A0P11.001
	Mainboard SF314-59 Intel Ci51135G7 8GB UMA	NB.A0P11.003
	Mainboard SF314-59 Intel Ci71165G7 8GB UMA	NB.A0P11.005
	Mainboard SF314-59 Intel Ci31115G4 16GB UMA	NB.A0P11.002
	Mainboard SF314-59 Intel Ci51135G7 16GB UMA	NB.A0P11.004
	Mainboard SF314-59 Intel Ci71165G7 16GB UMA	NB.A0P11.006
<b>POINT DEVICE</b>		
	TOUCHPAD ASSY SILVER-ELANTECH	56.HSFN2.001
	TOUCHPAD ASSY SILVER-SYNAPTICS	56.HSFN2.002
	TOUCHPAD ASSY PINK-ELANTECH	56.A0SN2.001
	TOUCHPAD ASSY PINK-SYNAPTICS	56.A0SN2.002

CATEGORY	Acer Description	AcerPN
	TOUCHPAD ASSY BLUE-ELANTECH	56.A0QN2.001
	TOUCHPAD ASSY BLUE-SYNAPTICS	56.A0QN2.002
<b>SPEAKER</b>		
	SPEAKER L	23.HSFN2.002
	SPEAKER R	23.HSFN2.003
<b>MISCELLANEOUS</b>		
	TAPE FOR BATTERY	47.HSFN2.001
	LCD PANEL ADHESIVE L FOR 3.0	47.HSFN2.002
	LCD PANEL ADHESIVE R FOR 3.0	47.HSFN2.003

# Screw List

**Table 6-5. Screw List**

CATEGORY	Acer Description	Acer PN
<b>SCREWS</b>		
	SCREW 2.5D 2.5L K 8D 0.6T ZK NL	86.H14N2.002
	SCREW 2.5D 5.0L K 4.6D NI NL	86.H14N2.003
	SCREW 2.0D 2.5L K 5D ZK NL	86.HSFN2.001
	SCREW 2.0D 4.5L K 4.5D 0.8T NI NL	86.HSFN2.002
	SCREW M M 2 2.0D 2L K 7D ZK NL CR3	86.HSFN2.003