

Exploded Diagrams

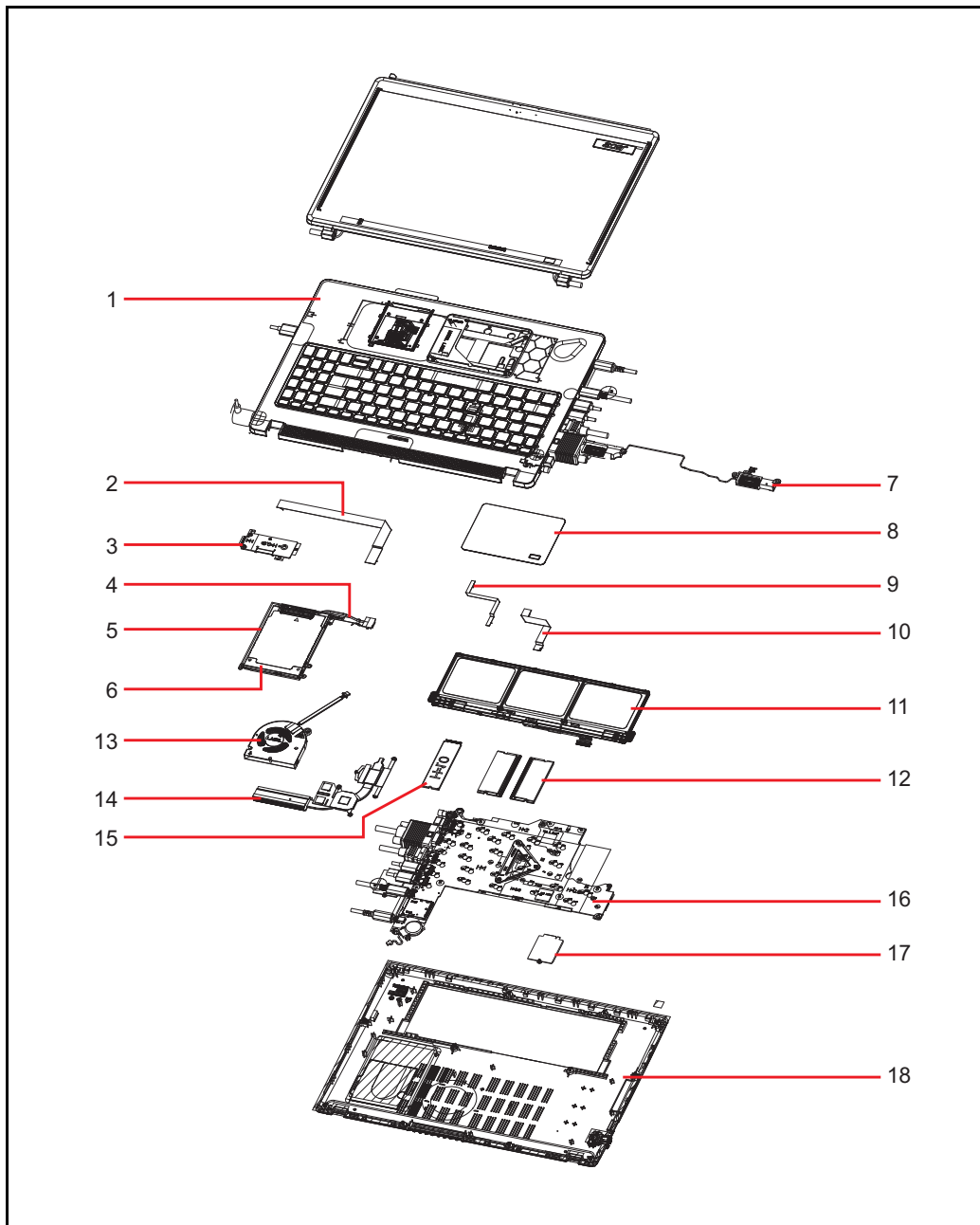

Figure 6-1. System Exploded Diagram

Table 6-1. System Exploded Diagram

No.	Description	Acer Part No.
1	UPPER CASE ASSY BL(Keyboard SV05P_A74SBWL SV5P Internal 15 Standard 100KS Black Arabic acer Commercial font White BL Power icon V0 Mylar, NK.I1513.0Y2)	6B.VLKN7.001

Table 6-1. System Exploded Diagram (Continued)

No.	Description	Acer Part No.
2	FFC CABLE USB/B(210MM,22P,60V)	50.VMNN7.002
3	USB BOARD	55.VMNN7.001
4	CABLE FOR HDD	50.VLEN7.001
5	HDD BRACKET	33.VMNN7.001
6	HDD SEAGATE 2.5" 7200rpm 1000GB ST1000LM049, 2GH172-188, RosewoodX 1TB, 7mmzh HDD SATA III 128MB LF F/W:ACM1	KH.01K01.067
7	SPEAKER R&L	23.VLLN7.002
8	TOUCH PAD W/MYLAR/PLATE/ADH BLACK SYC	56.VMNN7.001
9	FFC CABLE FP-MB(104.5MM,8P,60V)	50.VLVN7.001
10	FFC CABLE TP-MB(93.5MM,8P,60V)	50.VMNN7.001
11	Battery LGC AP18C Polymer 3S1P LGC 3 cell 4343mAh Main COMMON	KT.0030G.020
12	Memory KINGSTON SO-DIMM DDRIV 2666 4GB ACR26D4S9S1ME-4 LF+HF 512*16	KN.4GB07.036
13	FAN	23.VLLN7.001
14	HEAT SINK FOR DIS	24.VLLN7.001
14	HEAT SINK FOR UMA	24.VLLN7.002
15	Flash Disk SANDISK SSD NAND 512GB SDAPNUW-512G-1014 LF+HF	KN.5120D.004
16	Mainboard TMP215-52 I5-10210U UMA INTAX201.NGWG.NV_AX_w/BT 5.0 Dtpm	NB.VLN11.002
17	Wireless LAN Intel 802.11ax Bluetooth FM AX201.NGWG.NV WiFi 6 AX 2x2 HrP2 M.2 + BT 5.0 2230 No vPro	KE.11X0N.006
18	LOWER CASE ASSY	60.VMNN7.001

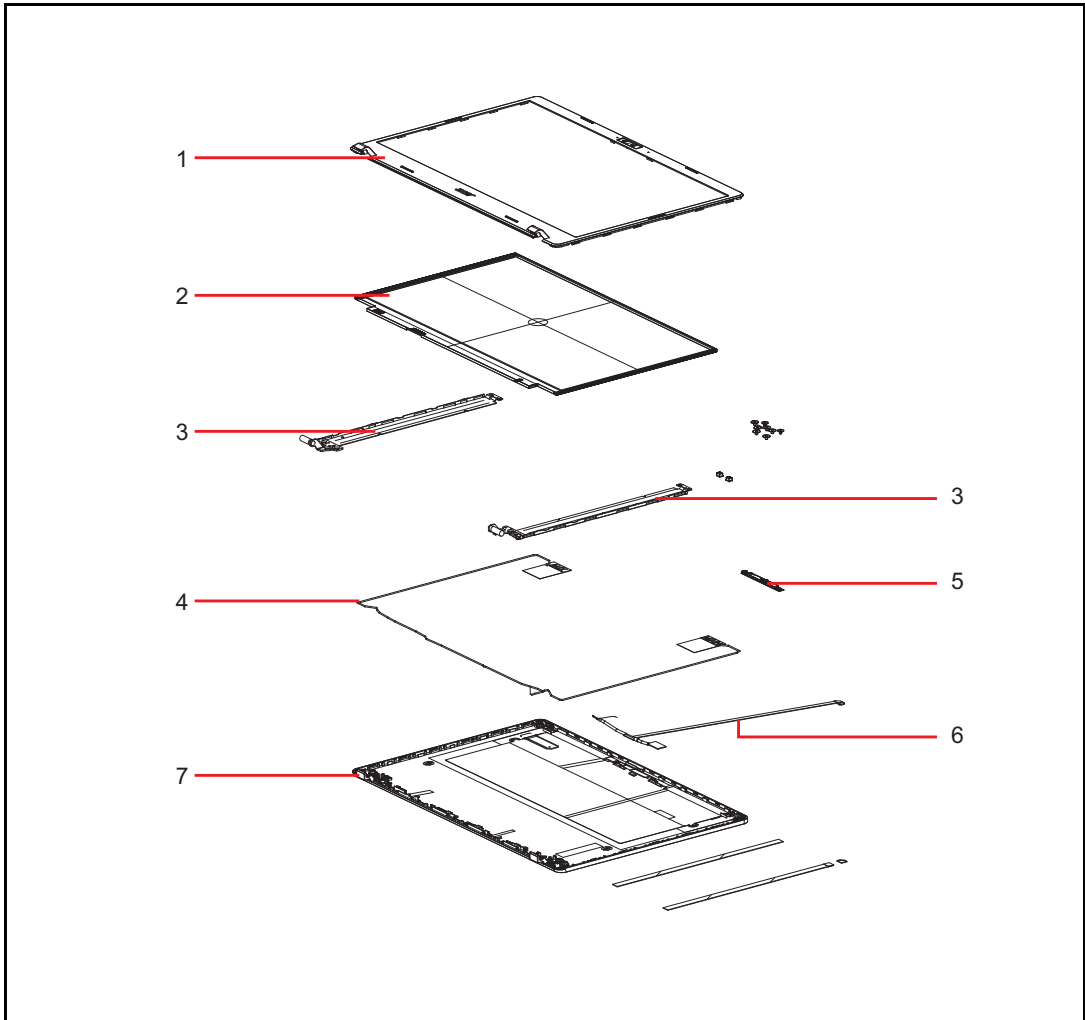

Figure 6-2. LCD Assembly Exploded Diagram

Table 6-2. LCD Assembly Exploded Diagram

No.	Description	Acer Part No.
1	LCD BEZEL	60.VMNN7.003
2	LED LCD Panel CMI 15.6"W FHD None Glare N156HGA-EA3 LF 220nit 10ms 500:1 (eDP, narrow border, 3.2mm max, value)	KL.1560D.035
3	HINGE R	33.VMNN7.002
	HINGE L	33.VMNN7.003
4	ANTENNA (MAIN+AUX,NGFF)	50.VMNN7.005
5	Camera Tech-Front HD Camera HD Camera TF_OV9734_SP2087L2_AOET_KMM4030 Unified2 (add Mic*2)	KS.0HD0Q.004
6	LCD CABLE(40/30/6P,30V)	50.VMNN7.008
7	LCD COVER ASSY	60.VMNN7.002

FRU List

TravelMate P215-52/P215-52G

Table 6-3. FRU List





Category	Description	Acer Part No.
ADAPTER		
	Adapter DELTA 45W 19V 1.1x3.0x7.7 Black ADP-45FE FD LF Black 45W_3phy,meet CoC Tier-2, IEC-62368	KP.04501.017
	Adapter Chicony Power 45W 19V 1.1x3.0x7.7 Black A045R072P LF Black Meet CoC Tier2 & IEC 62368, No acer logo	KP.0450H.013
	Adapter DELTA 45W_3phy INDIA 19V 1.1x3.0x7.7 Black ADP-45FE FE LF Black Meet CoC Tier2 & IEC 62368	KP.04501.022
	Adapter DELTA 65W 19V 1.1x3.0x7.7 Yellow ADP-65DE BA LF Black Meet DOE6, CoC Tier2, IEC 62368	KP.06501.012
	Adapter DELTA 65W_3phy INDIA 19V 1.1x3.0x7.7 Yellow ADP-65DE BH LF Black Meet CoC Tier2 & IEC 62368	KP.06501.015
	Adapter Chicony Power 65W 19V 1.1x3.0x7.7 Yellow A065R178P LF Black Meet IEC62368 & CoC Tier2, no acer logo	KP.0650H.013
BATTERY		
	Battery LGC Typ.50Wh 4470mAh 3S1P 248x84.4x5.5(mm) AP18C 11.25V 65W Polymer	KT.0030G.020
	Battery MURATA Typ.48Wh 4200mAh 3S1P 248x84.4x5.5(mm) AP18C 11.4V 60W Polymer	KT.00304.012
BOARD		
	Wireless LAN Intel 802.11ax Bluetooth FM AX201.NGWG.NV WiFi 6 AX 2x2 HrP2 M.2 + BT 5.0 2230 No vPro	KE.11X0N.006
	Quetel Wireless LTE M.2 Module EM06-E	NC.21311.00U
	LTE Quetel LTE EM06-E Quetel LTE Cat.6 EM06-E	KI.LTE0Q.00U

Table 6-3. FRU List (Continued)

Category	Description	Acer Part No.
	USB BOARD ASSY	55.VMNN7.001
	LTE BOARD ASSY	55.VLEN7.001
	TOUCH PAD W/MYLAR/PLATE/ADH BLACK SYNC	56.VMNN7.001
	TOUCH PAD W/MYLAR/PLATE/ADH FP BLACK SYNC	56.VLVN7.001
CABLE		
	POWER CORD 1M 125V EUR+KOR BLACK	27.NE307.015
	POWER CORD 1M 125V US BLACK	27.NE307.003
	POWER CORD 1M 125V JAP BLACK	27.NE307.001
	POWER CORD 1M 125V TAIWAN BLACK	27.NE307.002
	POWER CORD 1M 125V ARG BLACK	27.NE307.004
	POWER CORD 1M 125V AUS BLACK	27.NE307.005
	POWER CORD 1M 125V BRAZIL BLACK	27.NE307.006
	POWER CORD 1M 125V CHINA BLACK	27.NE307.007
	POWER CORD 1M 125V DENMARK BLACK	27.NE307.008
	POWER CORD 1M 125V INDIA BLACK	27.NE307.009
	POWER CORD 1M 125V ISRAEL BLACK	27.NE307.010
	POWER CORD 1M 125V ITL BLACK	27.NE307.011
	POWER CORD 1M 125V S.AFRICA BLACK	27.NE307.012
	POWER CORD 1M 125V SWISS BLACK	27.NE307.013
POWER CORD 1M 125V UK BLACK	27.NE307.014	
	FFC CABLE TP-MB(93.5MM,8P,60V)	50.VMNN7.001

Table 6-3. FRU List (Continued)

Category	Description	Acer Part No.
	FFC CABLE FP-MB(104.5MM,8P,60V)	50.VLVN7.001
	FFC CABLE USB/B(210MM,22P,60V)	50.VMNN7.002
	CABLE FOR HDD	50.VLEN7.001
	FFC CABLE FOR LTE/B(102MM,30P,60V)	50.VMNN7.004
	ANTENNA (MAIN+AUX,NGFF)	50.VMNN7.005
	ANTENNA (MAIN+AUX,NGFF) FOR LTE SKU	50.VMNN7.006
	CABLE FOR TUNNER ANTENNA(4/4P,30V)	50.VMNN7.007

Table 6-3. FRU List (Continued)





Category	Description	Acer Part No.
	LCD CABLE(40/30/6P,30V)	50.VMNN7.008
	LCD CABLE FOR LTE SKU	50.VMJN7.001
CAMERA		
	Camera Tech-Front HD Camera HD Camera TF_OV9734_SP2087L2_AOET_KMM4030 Unified2 (add Mic*2)	KS.0HD0Q.004
	Camera CHICONY HD Camera HD Camera CH_OV9734_RT55846N_AOET_SPK0493 Unified2 (add Mic*2)	KS.0HD06.012
CASE/COVER/BRACKET ASSEMBLY		
	LOWER CASE ASSY	60.VMNN7.001
	HDD BRACKET	33.VMNN7.001

Table 6-3. FRU List (Continued)

Category	Description	Acer Part No.
	LCD COVER ASSY	60.VMNN7.002
	LCD BEZEL	60.VMNN7.003
	HINGE R	33.VMNN7.002
	HINGE L	33.VMNN7.003
	SIM TRAY FOR LTE SKU	42.VLLN7.001
FAN SINK/SPEAKER/EARPHONE/RTC		
	FAN	23.VLLN7.001
	HEAT SINK FOR DIS	24.VLLN7.001
	HEAT SINK FOR UMA	24.VLLN7.002
	SPEAKER R&L	23.VLLN7.002

Table 6-3. FRU List (Continued)



Category	Description	Acer Part No.
HARD DISK DRIVE		
	HDD SEAGATE 2.5" 7200rpm 1000GB ST1000LM049, 2GH172-188, RosewoodX 1TB, 7mmzh HDD SATA III 128MB LF F/W:ACM1	KH.01K01.067
	HDD TOSHIBA 2.5" 5400rpm 500GB Aquarius-B, MQ01ABF050, 500G/P, 7mmzh SATA III 8MB LF+HF F/W:AM002J	KH.50004.015
	HDD TOSHIBA 2.5" 5400rpm 1000GB MQ04ABF100, 1TB/P, acer code SATA III 128MB LF+HF F/W:JU001J	KH.01K04.016
	HDD WD 2.5" 5400rpm 1000GB WD10SPZX-21Z10T0, 7mmzh 1D, 1TB/P, MN1000S SATA III 128MB LF F/W: 02.01A02	KH.01K08.035
	Flash Disk SANDISK SSD NAND 512GB SDAPNUW-512G-1014 LF+HF	KN.5120D.004
	Flash Disk SAMSUNG SSD NAND 512GB M.2 2280 PM991 MZVLQ512HALU-00000 LF+HF	KN.5120B.035
	Flash Disk SANDISK SSD NAND 128GB SDAPNUW-128G-1014 LF+HF	KN.1280D.010
	Flash Disk KINGSTON SSD NAND 128GB RBU-SNS8154P3/128GJ1 LF+HF	KN.12807.029
	Flash Disk KINGSTON SSD NAND 256GB RBU-SNS8154P3/256GJ1 LF+HF	KN.25607.025
	Flash Disk HYNIX SSD NAND 256GB HFM256GDJTN1-82A0A LF+HF	KN.2560G.029
KB ASSEMBLY		
	UPPER CASE ASSY BL(Keyboard SV05P_A74SBWL SV5P Internal 15 Standard 100KS Black Arabic acer Commercial font White BL Power icon V0 Mylar, NK.I1513.0Y2)	6B.VLKN7.001
	UPPER CASE ASSY BL(Keyboard SV05P_A74SBWL SV5P Internal 15 Standard 101KS Black FR/Arabic acer Commercial font White BL Power icon V0 Mylar, NK.I1513.0YK)	6B.VLKN7.002
	UPPER CASE ASSY BL(Keyboard SV05P_A74SBWL SV5P Internal 15 Standard 101KS Black Belgium acer Commercial font White BL Power icon V0 Mylar, NK.I1513.0YF)	6B.VLKN7.003

Table 6-3. FRU List (Continued)

Category	Description	Acer Part No.
	UPPER CASE ASSY BL(Keyboard SV05P_A74SBWL SV5P Internal 15 Standard 101KS Black Spanish acer Commercial font White BL Power icon V0 Mylar, NK.I1513.0YU)	6B.VLKN7.024
	UPPER CASE ASSY BL(Keyboard SV05P_A74SBWL SV5P Internal 15 Standard 101KS Black Sweden acer Commercial font White BL Power icon V0 Mylar, NK.I1513.0YV)	6B.VLKN7.025
	UPPER CASE ASSY BL(Keyboard SV05P_A74SBWL SV5P Internal 15 Standard 101KS Black Swiss/G acer Commercial font White BL Power icon V0 Mylar, NK.I1513.0YW)	6B.VLKN7.026
	UPPER CASE ASSY BL(Keyboard SV05P_A74SBWL SV5P Internal 15 Standard 100KS Black Traditional Chinese acer Commercial font White BL Power icon V0 Mylar,NK.I1513.0Y3)	6B.VLKN7.027
	UPPER CASE ASSY BL(Keyboard SV05P_A74SBWL SV5P Internal 15 Standard 100KS Black Thailand acer Commercial font White BL Power icon V0 Mylar, NK.I1513.0Y9)	6B.VLKN7.028
	UPPER CASE ASSY BL(Keyboard SV05P_A74SBWL SV5P Internal 15 Standard 101KS Black Turkish acer Commercial font White BL Power icon V0 Mylar, NK.I1513.0YX)	6B.VLKN7.029
	UPPER CASE ASSY BL(Keyboard SV05P_A74SBWL SV5P Internal 15 Standard 100KS Black US International acer Commercial font White BL Power icon V0 Mylar, NK.I1513.0YA)	6B.VLKN7.030
	UPPER CASE ASSY BL(Keyboard SV05P_A74SBWL SV5P Internal 15 Standard 101KS Black UK acer Commercial font White BL Power icon V0 Mylar, NK.I1513.0YY)	6B.VLKN7.031
	UPPER CASE ASSY BL(Keyboard SV05P_A74SBWL SV5P Internal 15 Standard 100KS Black Ukrainian acer Commercial font White BL Power icon V0 Mylar, NK.I1513.0Y7)	6B.VLKN7.032
	UPPER CASE ASSY(Keyboard SV05T_A74SB SV5T Internal 15 Standard 100KS Black Arabic acer Commercial font, Power icon V0 Mylar, NK.I1513.0Z0, NK.I1515.09M)	6B.VLTN7.001

Table 6-3. FRU List (Continued)

Category	Description	Acer Part No.
	UPPER CASE ASSY(Keyboard SV05T_A74SB SV5T Internal 15 Standard 101KS Black Nordic acer Commercial font, Power icon V0 Mylar, NK.I1513.0ZN, NK.I151S.0A9)	6B.VLTN7.023
	UPPER CASE ASSY(Keyboard SV05T_A74SB SV5T Internal 15 Standard 101KS Black Spanish acer Commercial font, Power icon V0 Mylar, NK.I1513.0ZS, NK.I151S.0AD)	6B.VLTN7.024
	UPPER CASE ASSY(Keyboard SV05T_A74SB SV5T Internal 15 Standard 101KS Black Sweden acer Commercial font, Power icon V0 Mylar, NK.I1513.0ZT, NK.I151S.0AE)	6B.VLTN7.025
	UPPER CASE ASSY(Keyboard SV05T_A74SB SV5T Internal 15 Standard 101KS Black Swiss/G acer Commercial font, Power icon V0 Mylar, NK.I1513.0ZU, NK.I151S.0AF)	6B.VLTN7.026
	UPPER CASE ASSY(Keyboard SV05T_A74SB SV5T Internal 15 Standard 100KS Black Traditional Chinese acer Commercial font, Power icon V0 Mylar, NK.I1513.0Z1, NK.I151S.09N)	6B.VLTN7.027
	UPPER CASE ASSY(Keyboard SV05T_A74SB SV5T Internal 15 Standard 100KS Black Thailand acer Commercial font, Power icon V0 Mylar, NK.I1513.0Z7, NK.I151S.09U)	6B.VLTN7.028
	UPPER CASE ASSY(Keyboard SV05T_A74SB SV5T Internal 15 Standard 101KS Black Turkish acer Commercial font, Power icon V0 Mylar, NK.I1513.0ZV, NK.I151S.0AG)	6B.VLTN7.029
	UPPER CASE ASSY(Keyboard SV05T_A74SB SV5T Internal 15 Standard 100KS Black US International acer Commercial font, Power icon V0 Mylar, NK.I1513.0Z8, NK.I151S.09V)	6B.VLTN7.030
	UPPER CASE ASSY(Keyboard SV05T_A74SB SV5T Internal 15 Standard 101KS Black UK acer Commercial font, Power icon V0 Mylar, NK.I1513.0ZW, NK.I151S.0AH)	6B.VLTN7.031
	UPPER CASE ASSY(Keyboard SV05T_A74SB SV5T Internal 15 Standard 100KS Black Ukrainian acer Commercial font, Power icon V0 Mylar, NK.I1513.0Z5, NK.I151S.09S)	6B.VLTN7.032

Table 6-3. FRU List (Continued)

Category	Description	Acer Part No.
	UPPER CASE ASSY BL WITH SIM HOLE(Keyboard SV05P_A74SBWL SV5P Internal 15 Standard 100KS Black Traditional Chinese acer Commercial font White BL Power icon V0 Mylar, NK.I1513.0Y3)	6B.VLKN7.059
	UPPER CASE ASSY BL WITH SIM HOLE(Keyboard SV05P_A74SBWL SV5P Internal 15 Standard 100KS Black Thailand acer Commercial font White BL Power icon V0 Mylar, NK.I1513.0Y9)	6B.VLKN7.060
	UPPER CASE ASSY BL WITH SIM HOLE(Keyboard SV05P_A74SBWL SV5P Internal 15 Standard 101KS Black Turkish acer Commercial font White BL Power icon V0 Mylar, NK.I1513.0YX)	6B.VLKN7.061
	UPPER CASE ASSY BL WITH SIM HOLE(Keyboard SV05P_A74SBWL SV5P Internal 15 Standard 100KS Black US International acer Commercial font White BL Power icon V0 Mylar, NK.I1513.0YA)	6B.VLKN7.062
	UPPER CASE ASSY BL WITH SIM HOLE(Keyboard SV05P_A74SBWL SV5P Internal 15 Standard 101KS Black UK acer Commercial font White BL Power icon V0 Mylar, NK.I1513.0YY)	6B.VLKN7.063
	UPPER CASE ASSY BL WITH SIM HOLE(Keyboard SV05P_A74SBWL SV5P Internal 15 Standard 100KS Black Ukrainian acer Commercial font White BL Power icon V0 Mylar, NK.I1513.0Y7)	6B.VLKN7.064
	UPPER CASE ASSY WITH SIM HOLE(Keyboard SV05T_A74SB SV5T Internal 15 Standard 100KS Black Arabic acer Commercial font, Power icon V0 Mylar, NK.I1513.0Z0, NK.I151S.09M)	6B.VLTN7.033
	UPPER CASE ASSY WITH SIM HOLE(Keyboard SV05T_A74SB SV5T Internal 15 Standard 101KS Black FR/Arabic acer Commercial font, Power icon V0 Mylar, NK.I1513.0ZH, NK.I151S.0A4)	6B.VLTN7.034
	UPPER CASE ASSY WITH SIM HOLE(Keyboard SV05T_A74SB SV5T Internal 15 Standard 101KS Black Belgium acer Commercial font, Power icon V0 Mylar, NK.I1513.0ZD, NK.I151S.0A0)	6B.VLTN7.035

Table 6-3. FRU List (Continued)

Category	Description	Acer Part No.
	UPPER CASE ASSY WITH SIM HOLE(Keyboard SV05T_A74SB SV5T Internal 15 Standard 101KS Black UK acer Commercial font, Power icon V0 Mylar, NK.I1513.0ZW, NK.I151S.0AH)	6B.VLTN7.063
	UPPER CASE ASSY WITH SIM HOLE(Keyboard SV05T_A74SB SV5T Internal 15 Standard 100KS Black Ukrainian acer Commercial font, Power icon V0 Mylar, NK.I1513.0Z5, NK.I151S.09S)	6B.VLTN7.064
	UPPER CASE ASSY BL WITH Smart Card HOLE(Keyboard CHICONY SV05P_A74SBWL SV5P Internal 15 Standard 100KS Black Arabic acer Commercial font White BL Power icon V0 Mylar, NK.I1513.0Y2)	6B.VLKN7.065
	UPPER CASE ASSY BL WITH Smart Card HOLE(Keyboard CHICONY SV05P_A74SBWL SV5P Internal 15 Standard 101KS Black FR/Arabic acer Commercial font White BL Power icon V0 Mylar, NK.I1513.0YK)	6B.VLKN7.066
	UPPER CASE ASSY BL WITH Smart Card HOLE(Keyboard CHICONY SV05P_A74SBWL SV5P Internal 15 Standard 101KS Black Belgium acer Commercial font White BL Power icon V0 Mylar, NK.I1513.0YF)	6B.VLKN7.067
	UPPER CASE ASSY BL WITH Smart Card HOLE(Keyboard CHICONY SV05P_A74SBWL SV5P Internal 15 Standard 101KS Black Brazilian Portuguese acer Commercial font White BL Power icon V0 Mylar, NK.I1513.0YG)	6B.VLKN7.068
	UPPER CASE ASSY BL WITH Smart Card HOLE(Keyboard CHICONY SV05P_A74SBWL SV5P Internal 15 Standard 100KS Black US International w/ Bulgaria acer Commercial font White BL Power icon V0 Mylar, NK.I1513.0YD)	6B.VLKN7.069
	UPPER CASE ASSY BL WITH Smart Card HOLE(Keyboard CHICONY SV05P_A74SBWL SV5P Internal 15 Standard 100KS Black US International w/ Canadian French acer Commercial font White BL Power icon V0 Mylar, NK.I1513.0YC)	6B.VLKN7.070
	UPPER CASE ASSY BL WITH Smart Card HOLE(Keyboard CHICONY SV05P_A74SBWL SV5P Internal 15 Standard 101KS Black SLO/CRO acer Commercial font White BL Power icon V0 Mylar, NK.I1513.0YT)	6B.VLKN7.071

Table 6-3. FRU List (Continued)

Category	Description	Acer Part No.
	UPPER CASE ASSY BL WITH Smart Card HOLE(Keyboard CHICONY SV05P_A74SBWL SV5P Internal 15 Standard 101KS Black Swiss/G acer Commercial font White BL Power icon V0 Mylar, NK.I1513.0YW)	6B.VLKN7.090
	UPPER CASE ASSY BL WITH Smart Card HOLE(Keyboard CHICONY SV05P_A74SBWL SV5P Internal 15 Standard 100KS Black Traditional Chinese acer Commercial font White BL Power icon V0 Mylar, NK.I1513.0Y3)	6B.VLKN7.091
	UPPER CASE ASSY BL WITH Smart Card HOLE(Keyboard CHICONY SV05P_A74SBWL SV5P Internal 15 Standard 100KS Black Thailand acer Commercial font White BL Power icon V0 Mylar, NK.I1513.0Y9)	6B.VLKN7.092
	UPPER CASE ASSY BL WITH Smart Card HOLE(Keyboard CHICONY SV05P_A74SBWL SV5P Internal 15 Standard 101KS Black Turkish acer Commercial font White BL Power icon V0 Mylar, NK.I1513.0YX)	6B.VLKN7.093
	UPPER CASE ASSY BL WITH Smart Card HOLE(Keyboard CHICONY SV05P_A74SBWL SV5P Internal 15 Standard 100KS Black US International acer Commercial font White BL Power icon V0 Mylar, NK.I1513.0YA)	6B.VLKN7.094
	UPPER CASE ASSY BL WITH Smart Card HOLE(Keyboard CHICONY SV05P_A74SBWL SV5P Internal 15 Standard 101KS Black UK acer Commercial font White BL Power icon V0 Mylar, NK.I1513.0YY)	6B.VLKN7.095
	UPPER CASE ASSY BL WITH Smart Card HOLE(Keyboard CHICONY SV05P_A74SBWL SV5P Internal 15 Standard 100KS Black Ukrainian acer Commercial font White BL Power icon V0 Mylar, NK.I1513.0Y7)	6B.VLKN7.096
	UPPER CASE ASSY WITH Smart Card HOLE(Keyboard CHICONY SV05T_A74SB SV5T Internal 15 Standard 100KS Black Arabic acer Commercial font, Power icon V0 Mylar, NK.I1513.0Z0, NK.I151S.09M)	6B.VLTN7.065
	UPPER CASE ASSY WITH Smart Card HOLE(Keyboard CHICONY SV05T_A74SB SV5T Internal 15 Standard 101KS Black FR/Arabic acer Commercial font, Power icon V0 Mylar, NK.I1513.0ZH, NK.I151S.0A4)	6B.VLTN7.066

Table 6-3. FRU List (Continued)

Category	Description	Acer Part No.
	UPPER CASE ASSY WITH Smart Card HOLE(Keyboard CHICONY SV05T_A74SB SV5T Internal 15 Standard 101KS Black Turkish acer Commercial font, Power icon V0 Mylar, NK.I1513.0ZV, NK.I151S.0AG)	6B.VLTN7.093
	UPPER CASE ASSY WITH Smart Card HOLE(Keyboard CHICONY SV05T_A74SB SV5T Internal 15 Standard 100KS Black US International acer Commercial font, Power icon V0 Mylar, NK.I1513.0Z8, NK.I151S.09V)	6B.VLTN7.094
	UPPER CASE ASSY WITH Smart Card HOLE(Keyboard CHICONY SV05T_A74SB SV5T Internal 15 Standard 101KS Black UK acer Commercial font, Power icon V0 Mylar, NK.I1513.0ZW, NK.I151S.0AH)	6B.VLTN7.095
	UPPER CASE ASSY WITH Smart Card HOLE(Keyboard CHICONY SV05T_A74SB SV5T Internal 15 Standard 100KS Black Ukrainian acer Commercial font, Power icon V0 Mylar, NK.I1513.0Z5, NK.I151S.09S)	6B.VLTN7.096
	UPPER CASE ASSY BL WITH LTE/Smart Card HOLE(Keyboard CHICONY SV05P_A74SBWL SV5P Internal 15 Standard 100KS Black Arabic acer Commercial font White BL Power icon V0 Mylar, NK.I1513.0Y2)	6B.VLKN7.097
	UPPER CASE ASSY BL WITH LTE/Smart Card HOLE(Keyboard CHICONY SV05P_A74SBWL SV5P Internal 15 Standard 101KS Black FR/Arabic acer Commercial font White BL Power icon V0 Mylar, NK.I1513.0YK)	6B.VLKN7.098
	UPPER CASE ASSY BL WITH LTE/Smart Card HOLE(Keyboard CHICONY SV05P_A74SBWL SV5P Internal 15 Standard 101KS Black Belgium acer Commercial font White BL Power icon V0 Mylar, NK.I1513.0YF)	6B.VLKN7.099
	UPPER CASE ASSY BL WITH LTE/Smart Card HOLE(Keyboard CHICONY SV05P_A74SBWL SV5P Internal 15 Standard 101KS Black Brazilian Portuguese acer Commercial font White BL Power icon V0 Mylar, NK.I1513.0YG)	6B.VLKN7.101
	UPPER CASE ASSY BL WITH LTE/Smart Card HOLE(Keyboard CHICONY SV05P_A74SBWL SV5P Internal 15 Standard 100KS Black US International w/ Bulgaria acer Commercial font White BL Power icon V0 Mylar, NK.I1513.0YD)	6B.VLKN7.102

Table 6-3. FRU List (Continued)

Category	Description	Acer Part No.
	UPPER CASE ASSY BL WITH LTE/Smart Card HOLE(Keyboard CHICONY SV05P_A74SBWL SV5P Internal 15 Standard 100KS Black Ukrainian acer Commercial font White BL Power icon V0 Mylar, NK.I1513.0Y7)	6B.VLKN7.129
	UPPER CASE ASSY WITH LTE/Smart Card HOLE(Keyboard CHICONY SV05T_A74SB SV5T Internal 15 Standard 100KS Black Arabic acer Commercial font, Power icon V0 Mylar, NK.I1513.0Z0, NK.I1515.09M)	6B.VLTN7.097
	UPPER CASE ASSY WITH LTE/Smart Card HOLE(Keyboard CHICONY SV05T_A74SB SV5T Internal 15 Standard 101KS Black FR/Arabic acer Commercial font, Power icon V0 Mylar, NK.I1513.0ZH, NK.I1515.0A4)	6B.VLTN7.098
	UPPER CASE ASSY WITH LTE/Smart Card HOLE(Keyboard CHICONY SV05T_A74SB SV5T Internal 15 Standard 101KS Black Belgium acer Commercial font, Power icon V0 Mylar, NK.I1513.0ZD, NK.I1515.0A0)	6B.VLTN7.099
	UPPER CASE ASSY WITH LTE/Smart Card HOLE(Keyboard CHICONY SV05T_A74SB SV5T Internal 15 Standard 101KS Black Brazilian Portuguese acer Commercial font, Power icon V0 Mylar, NK.I1513.0ZE, NK.I1515.0A1)	6B.VLTN7.101
	UPPER CASE ASSY WITH LTE/Smart Card HOLE(Keyboard CHICONY SV05T_A74SB SV5T Internal 15 Standard 100KS Black US International w/ Bulgaria acer Commercial font, Power icon V0 Mylar, NK.I1513.0ZB, NK.I1515.09Y)	6B.VLTN7.102
	UPPER CASE ASSY WITH LTE/Smart Card HOLE(Keyboard CHICONY SV05T_A74SB SV5T Internal 15 Standard 100KS Black US International w/ Canadian French acer Commercial font, Power icon V0 Mylar, NK.I1513.0ZA, NK.I1515.09X)	6B.VLTN7.103
	UPPER CASE ASSY WITH LTE/Smart Card HOLE(Keyboard CHICONY SV05T_A74SB SV5T Internal 15 Standard 101KS Black SLO/CRO acer Commercial font, Power icon V0 Mylar, NK.I1513.0ZR, NK.I1515.0AC)	6B.VLTN7.104

Table 6-3. FRU List (Continued)



Category	Description	Acer Part No.
	UPPER CASE ASSY WITH LTE/Smart Card HOLE(Keyboard CHICONY SV05T_A74SB SV5T Internal 15 Standard 101KS Black Swiss/G acer Commercial font, Power icon V0 Mylar, NK.I1513.0ZU, NK.I151S.0AF)	6B.VLTN7.123
	UPPER CASE ASSY WITH LTE/Smart Card HOLE(Keyboard CHICONY SV05T_A74SB SV5T Internal 15 Standard 100KS Black Traditional Chinese acer Commercial font, Power icon V0 Mylar, NK.I1513.0Z1, NK.I151S.09N)	6B.VLTN7.124
	UPPER CASE ASSY WITH LTE/Smart Card HOLE(Keyboard CHICONY SV05T_A74SB SV5T Internal 15 Standard 100KS Black Thailand acer Commercial font, Power icon V0 Mylar, NK.I1513.0Z7, NK.I151S.09U)	6B.VLTN7.125
	UPPER CASE ASSY WITH LTE/Smart Card HOLE(Keyboard CHICONY SV05T_A74SB SV5T Internal 15 Standard 101KS Black Turkish acer Commercial font, Power icon V0 Mylar, NK.I1513.0ZV, NK.I151S.0AG)	6B.VLTN7.126
	UPPER CASE ASSY WITH LTE/Smart Card HOLE(Keyboard CHICONY SV05T_A74SB SV5T Internal 15 Standard 100KS Black US International acer Commercial font, Power icon V0 Mylar, NK.I1513.0Z8, NK.I151S.09V)	6B.VLTN7.127
	UPPER CASE ASSY WITH LTE/Smart Card HOLE(Keyboard CHICONY SV05T_A74SB SV5T Internal 15 Standard 101KS Black UK acer Commercial font, Power icon V0 Mylar, NK.I1513.0ZW, NK.I151S.0AH)	6B.VLTN7.128
	UPPER CASE ASSY WITH LTE/Smart Card HOLE(Keyboard CHICONY SV05T_A74SB SV5T Internal 15 Standard 100KS Black Ukrainian acer Commercial font, Power icon V0 Mylar, NK.I1513.0Z5, NK.I151S.09S)	6B.VLTN7.129
	LCD	
	LED LCD Panel CMI 15.6"W FHD None Glare N156HGA-EA3 LF 220nit 10ms 500:1 (eDP, narrow border, 3.2mm max, value)	KL.1560D.035
	LED LCD Panel CMI 15.6"W WXGA None Glare N156BGA-EA3 LF 220nit 10ms 500:1 (eDP, 3.2mm Max, narrow border)	KL.1560D.034
	LED LCD Panel AUO 15.6"W FHD None Glare B156HTN06.1 LF 220nit 8ms 400:1 (eDP, narrow border, 3.2mm max, value)	KL.15605.050

Table 6-3. FRU List (Continued)



Category	Description	Acer Part No.
	LED LCD Panel AUO 15.6'W WXGA None Glare B156XTN08.1 LF 220nit 8ms 400:1 (eDP, 3.2mm Max, narrow border)	KL.15605.048
	LED LCD Panel AUO 15.6'W FHD None Glare B156HAN02.1 LF 250nit 25ms 700:1 (eDP, value IPS, narrow border)	KL.15605.040
	LED LCD Panel AUO 15.6'W FHD None Glare B156HAN02.1 H/W:4B LF 250nit 25ms 700:1 (eDP, value IPS, narrow border)	KL.15605.062
	LED LCD Panel BOE 15.6'W FHD None Glare NV156FHM-N48 V8.1 LF 250nit 30ms 800:1 (eDP, value IPS, narrow border)	KL.1560E.017
MAINBOARD		
	Mainboard TMP215-52 I5-10210U UMA INTAX201.NGWG.NV_AX_w/BT 5.0 Dtpm	NB.VLN11.002
	Mainboard TMP215-52 I7-10510U UMA INTAX201.NGWG.NV_AX_w/BT 5.0 Dtpm	NB.VLN11.003
	Mainboard TMP215-52 I3-10110U UMA INTAX201.NGWG.NV_AX_w/BT 5.0 dTPM	NB.VLN11.001
	Mainboard TMP215-52G I5-10210U N17SG0 2GB INTAX201.NGWG.NV_AX_w/BT 5.0 dTPM	NB.VLU11.002
	Mainboard TMP215-52G I7-10510U N17SG0 2GB INTAX201.NGWG.NV_AX_w/BT 5.0 dTPM	NB.VLU11.003
	Mainboard TMP215-52G I3-10110U N17SG0 2GB INTAX201.NGWG.NV_AX_w/BT 5.0 dTPM	NB.VLU11.001

Table 6-3. FRU List (Continued)











Category	Description	Acer Part No.
	Mainboard TMP215-52 I5-10210U UMA INTAX201.NGWG.NV_AX_w/BT 5.0 dTPM, LTE	NB.VMN11.002
	Mainboard TMP215-52 I7-10510U UMA INTAX201.NGWG.NV_AX_w/BT 5.0 dTPM, LTE	NB.VMN11.003
	Mainboard TMP215-52 I3-10110U UMA INTAX201.NGWG.NV_AX_w/BT 5.0 dTPM, LTE	NB.VMN11.001
MEMORY		
	Memory KINGSTON SO-DIMM DDRIV 2666 4GB ACR26D4S9S1ME-4 LF+HF 512*16	KN.4GB07.036
	Memory KINGSTON SO-DIMM DDRIV 2666 16GB ACR26D4S9D8ME-16 LF+HF 1024*8	KN.16G07.028
	Memory KINGSTON SO-DIMM DDRIV 2666 8GB ACR26D4S9S8ME-8 LF+HF 1024*8	KN.8GB07.042
	Memory HYNIX SO-DIMM DDRIV 2666 4GB HMA851S6JJR6N-VK LF+HF 512*16 J-die	KN.4GB0G.052
	Memory HYNIX SO-DIMM DDRIV 2666 8GB HMA81GS6JJR8N-VK LF+HF 1024*8 J-die	KN.8GB0G.068
	Memory HYNIX SO-DIMM DDRIV 2666 16GB HMA82GS6CJR8N-VK LF+HF 1024*8 1Xnm, AL	KN.16G0G.031
MISCELLANEOUS		
	LCD ADHESIVE TAPE	47.VMNN7.001
	RUBBER SI FOR MIC	47.VLLN7.001
	ACETATE TAPE FOR BATTERY(21*21mm)	47.HKKN7.001
	ACETATE TAPE FOR KEYBOARD	47.HNBN7.001

Table 6-3. FRU List (Continued)

Category	Description	Acer Part No.
	CONDUCTIVE TAPE	47.VLLN7.002
	BATTERY MYLAR	47.VMLN7.003
	INS MYLAR FOR LCD PANEL	47.HKCN7.001
	COMPOSITE FOIL FOR TOP GPU	47.VLLN7.003

TravelMate P215-53/P215-53G

Table 6-4. FRU List

Category	Description	Acer Part No.
ADAPTER		
	Adapter Chicony Power 45W 19V 1.1x3.0x7.7 Black A045R072P LF Black Meet CoC Tier2 & IEC 62368, No acer logo	KP.0450H.013
	Adapter DELTA 65W 19V 1.1x3.0x7.7 Yellow ADP-65DE BA LF Black Meet DOE6, CoC Tier2, IEC 62368	KP.06501.012
	Adapter Chicony Power 65W 19V 1.1x3.0x7.7 Yellow A065R178P LF Black Meet IEC62368 & CoC Tier2, no acer logo	KP.0650H.013
BATTERY		
	Battery LGC Typ.50Wh 4470mAh 3S1P 248x84.4x5.5(mm) AP18C 11.25V 65W Polymer	KT.0030G.020
	Battery MURATA Typ.48Wh 4200mAh 3S1P 248x84.4x5.5(mm) AP18C 11.4V 60W Polymer	KT.00304.012
BOARD		
	Wireless LAN Intel 802.11ax Bluetooth FM AX201.NGWW.NVW WiFi 6 AX 2x2 HrP2 M.2+BT 5.0 2230 No vPro NewOTP SKU	KE.11X0N.014
	LTE Quectel LTE EM06-E Quectel LTE Cat.6 EM06-E	KI.LTE0Q.00U
	I/O BOARD	55.VPXN7.001
	LTE BOARD	55.VPSN7.001
	TOUCH PAD W/MYLAR/PLATE/ADH BLACK SYC	56.VMNN7.001

Table 6-4. FRU List (Continued)

Category	Description	Acer Part No.
	TOUCH PAD W/MYLAR/PLATE/ADH FP BLACK SYC	56.VLVN7.001
CABLE		
	FFC CABLE TP-MB(93.5MM,8P,60V)	50.VMNN7.001
	FFC CABLE FP-MB(104.5MM,8P,60V)	50.VLVN7.001
	FFC CABLE USB/B(210MM,22P,60V)	50.VMNN7.002
	CABLE FOR HDD	50.VLEN7.001
	FFC CABLE FOR LTE/B(102MM,30P,60V)	50.VMNN7.004
	ANTENNA (MAIN+AUX,NGFF)	50.VMNN7.005

Table 6-4. FRU List (Continued)





Category	Description	Acer Part No.
	ANTENNA (MAIN+AUX,NGFF) FOR LTE SKU	50.VMNN7.006
	CABLE FOR TUNNER ANTENNA(4/4P,30V)	50.VMNN7.007
	LCD CABLE(40/30/6P,30V)	50.VMNN7.008
	LCD CABLE FOR LTE SKU	50.VMJN7.001
CAMERA		
	Camera Tech-Front HD Camera HD Camera TF_OV9734_SP2087L2_AOET_KMM4030 Unified2 (add Mic*2)	KS.0HD0Q.004

Table 6-4. FRU List (Continued)

Category	Description	Acer Part No.
	Camera CHICONY HD Camera HD Camera CH_OV9734_RTS5846_Powertip_FG6531S_Teams (add Mic*2)	KS.0HD06.020
CASE/COVER/BRACKET ASSEMBLY		
	LOWER CASE ASSY	60.VMNN7.001
	HDD BRACKET	33.VMNN7.001
	LCD COVER ASSY	60.VMNN7.002
	LCD BEZEL	60.VMNN7.003
	HINGE R	33.VMNN7.002
	HINGE L	33.VMNN7.003
	SIM TRAY FOR LTE SKU	42.VLLN7.001
FAN SINK/SPEAKER/EARPHONE/RTC		
	FAN	23.VLLN7.001

Table 6-4. FRU List (Continued)







Category	Description	Acer Part No.
	HEAT SINK 15W DIS	24.VPXN7.001
	HEAT SINK 15W UMA	24.VPSN7.001
	SPEAKER R&L	23.VLLN7.002
HARD DISK DRIVE		
	HDD TOSHIBA 2.5" 5400rpm 500GB Aquarius-B,MQ01ABF050,500G/P, 7mmzh SATA III 8MB LF+HF F/W:AM002J	KH.50004.015
	HDD WD 2.5" 5400rpm 1000GB WD10SPZX-21Z10T0, 7mmzh 1D, 1TB/P, MN1000S SATA III 128MB LF F/W: 02.01A02	KH.01K08.035
	HDD WD 2.5" 5400rpm 2000GB WD20SPZX-21UA7T0, 7mmzh 2D, 1TB/P, MN1000M SATA III 128MB LF F/W:01.01A01	KH.02K08.020
	Flash Disk SAMSUNG SSD NAND 128GB M.2 2280 PM991 MZVLQ128HBHQ-00000 FW# FXV7101Q LF+HF	KN.1280B.011
	Flash Disk SANDISK SSD NAND 256GB BiCS4 SN530 SDBPNPZ-256G-1114 LF+HF	KN.2560D.017
	Flash Disk SANDISK SSD NAND 512GB BiCS4 SN530 SDBPNPZ-512G-1114 LF+HF	KN.5120D.012
	Flash Disk SAMSUNG SSD NAND 1024GB M.2 2280 PM991 MZVLQ1T0HALB-00000 FW# FXV7101Q LF+HF	KN.01K0B.004
KB ASSEMBLY		
	UPPER CASE ASSY W/ BL Keyboard SV05P_A74SBWL SV5P Internal 15 Standard 100KS Black Arabic White BL NK.I1513.0Y2	6B.VPUN7.001
	UPPER CASE ASSY W/ BL Keyboard SV05P_A74SBWL SV5P Internal 15 Standard 101KS Black FR/Arabic White BL NK.I1513.0YK	6B.VPUN7.002

Table 6-4. FRU List (Continued)

Category	Description	Acer Part No.
	UPPER CASE ASSY W/ BL Keyboard SV05P_A74SBWL SV5P Internal 15 Standard 101KS Black Belgium White BL NK.I1513.0YF	6B.VPUN7.003
	UPPER CASE ASSY W/ BL Keyboard SV05P_A74SBWL SV5P Internal 15 Standard 101KS Black Brazilian Portuguese White BL NK.I1513.0YG	6B.VPUN7.004
	UPPER CASE ASSY W/ BL Keyboard SV05P_A74SBWL SV5P Internal 15 Standard 100KS Black US International w/ Bulgaria White BL NK.I1513.0YD	6B.VPUN7.005
	UPPER CASE ASSY W/ BL Keyboard SV05P_A74SBWL SV5P Internal 15 Standard 100KS Black US International w/ Canadian French White BL NK.I1513.0YC	6B.VPUN7.006
	UPPER CASE ASSY W/ BL Keyboard SV05P_A74SBWL SV5P Internal 15 Standard 101KS Black SLO/CRO White BL NK.I1513.0YT	6B.VPUN7.007
	UPPER CASE ASSY W/ BL Keyboard SV05P_A74SBWL SV5P Internal 15 Standard 101KS Black CZ/SK White BL NK.I1513.0YH	6B.VPUN7.008
	UPPER CASE ASSY W/ BL Keyboard SV05P_A74SBWL SV5P Internal 15 Standard 101KS Black Danish White BL NK.I1513.0YJ	6B.VPUN7.009
	UPPER CASE ASSY W/ BL Keyboard SV05P_A74SBWL SV5P Internal 15 Standard 101KS Black French White BL NK.I1513.0YL	6B.VPUN7.010
	UPPER CASE ASSY W/ BL Keyboard SV05P_A74SBWL SV5P Internal 15 Standard 101KS Black German White BL NK.I1513.0YM	6B.VPUN7.011
	UPPER CASE ASSY W/ BL Keyboard SV05P_A74SBWL SV5P Internal 15 Standard 100KS Black Greek White BL NK.I1513.0Y4	6B.VPUN7.012
	UPPER CASE ASSY W/ BL Keyboard SV05P_A74SBWL SV5P Internal 15 Standard 100KS Black US International w/ Hebrew White BL NK.I1513.0YB	6B.VPUN7.013
	UPPER CASE ASSY W/ BL Keyboard SV05P_A74SBWL SV5P Internal 15 Standard 101KS Black Hungarian White BL NK.I1513.0YN	6B.VPUN7.014
	UPPER CASE ASSY W/ BL Keyboard SV05P_A74SBWL SV5P Internal 15 Standard 100KS Black Persian White BL NK.I1513.0Y8	6B.VPUN7.015

Table 6-4. FRU List (Continued)

Category	Description	Acer Part No.
	UPPER CASE ASSY W/ BL Keyboard SV05P_A74SBWL SV5P Internal 15 Standard 101KS Black Italian White BL NK.I1513.0YP	6B.VPUN7.016
	UPPER CASE ASSY W/ BL Keyboard SV05P_A74SBWL SV5P Internal 15 Standard 104KS Black Japanese White BL NK.I1513.0YZ	6B.VPUN7.017
	UPPER CASE ASSY W/ BL Keyboard SV05P_A74SBWL SV5P Internal 15 Standard 100KS Black Korean White BL NK.I1513.0Y5	6B.VPUN7.018
	UPPER CASE ASSY W/ BL Keyboard SV05P_A74SBWL SV5P Internal 15 Standard 101KS Black ALA-Spanish White BL NK.I1513.0YE	6B.VPUN7.019
	UPPER CASE ASSY W/ BL Keyboard SV05P_A74SBWL SV5P Internal 15 Standard 101KS Black Norwegian White BL NK.I1513.0YR	6B.VPUN7.020
	UPPER CASE ASSY W/ BL Keyboard SV05P_A74SBWL SV5P Internal 15 Standard 101KS Black Portuguese White BL NK.I1513.0YS	6B.VPUN7.021
	UPPER CASE ASSY W/ BL Keyboard SV05P_A74SBWL SV5P Internal 15 Standard 100KS Black Russian White BL NK.I1513.0Y6	6B.VPUN7.022
	UPPER CASE ASSY W/ BL Keyboard SV05P_A74SBWL SV5P Internal 15 Standard 101KS Black Nordic White BL NK.I1513.0YQ	6B.VPUN7.023
	UPPER CASE ASSY W/ BL Keyboard SV05P_A74SBWL SV5P Internal 15 Standard 101KS Black Spanish White BL NK.I1513.0YU	6B.VPUN7.024
	UPPER CASE ASSY W/ BL Keyboard SV05P_A74SBWL SV5P Internal 15 Standard 101KS Black Sweden White BL NK.I1513.0YV	6B.VPUN7.025
	UPPER CASE ASSY W/ BL Keyboard SV05P_A74SBWL SV5P Internal 15 Standard 101KS Black Swiss/G White BL NK.I1513.0YW	6B.VPUN7.026
	UPPER CASE ASSY W/ BL Keyboard SV05P_A74SBWL SV5P Internal 15 Standard 100KS Black Traditional Chinese White BL NK.I1513.0Y3	6B.VPUN7.027
	UPPER CASE ASSY W/ BL Keyboard SV05P_A74SBWL SV5P Internal 15 Standard 100KS Black Thailand White BL NK.I1513.0Y9	6B.VPUN7.028

Table 6-4. FRU List (Continued)

Category	Description	Acer Part No.
	UPPER CASE ASSY W/ BL Keyboard SV05P_A74SBWL SV5P Internal 15 Standard 101KS Black Turkish White BL NK.I1513.0YX	6B.VPUN7.029
	UPPER CASE ASSY W/ BL Keyboard SV05P_A74SBWL SV5P Internal 15 Standard 100KS Black US International White BL NK.I1513.0YA	6B.VPUN7.030
	UPPER CASE ASSY W/ BL Keyboard SV05P_A74SBWL SV5P Internal 15 Standard 101KS Black UK White BL NK.I1513.0YY	6B.VPUN7.031
	UPPER CASE ASSY W/ BL Keyboard SV05P_A74SBWL SV5P Internal 15 Standard 100KS Black Ukrainian White BL NK.I1513.0Y7	6B.VPUN7.032
	UPPER CASE ASSY LTE SKU W/ BL Keyboard SV05P_A74SBWL SV5P Internal 15 Standard 100KS Black Arabic White BL NK.I1513.0Y2	6B.VPWN7.001
	UPPER CASE ASSY LTE SKU W/ BL Keyboard SV05P_A74SBWL SV5P Internal 15 Standard 101KS Black FR/Arabic White BL NK.I1513.0YK	6B.VPWN7.002
	UPPER CASE ASSY LTE SKU W/ BL Keyboard SV05P_A74SBWL SV5P Internal 15 Standard 101KS Black Belgium White BL NK.I1513.0YF	6B.VPWN7.003
	UPPER CASE ASSY LTE SKU W/ BL Keyboard SV05P_A74SBWL SV5P Internal 15 Standard 101KS Black Brazilian Portuguese White BL NK.I1513.0YG	6B.VPWN7.004
	UPPER CASE ASSY LTE SKU W/ BL Keyboard SV05P_A74SBWL SV5P Internal 15 Standard 100KS Black US International w/ Canadian French White BL NK.I1513.0YC	6B.VPWN7.005
	UPPER CASE ASSY LTE SKU W/ BL Keyboard SV05P_A74SBWL SV5P Internal 15 Standard 101KS Black CZ/SK White BL NK.I1513.0YH	6B.VPWN7.006
	UPPER CASE ASSY LTE SKU W/ BL Keyboard SV05P_A74SBWL SV5P Internal 15 Standard 101KS Black Danish White BL NK.I1513.0YJ	6B.VPWN7.007
	UPPER CASE ASSY LTE SKU W/ BL Keyboard SV05P_A74SBWL SV5P Internal 15 Standard 101KS Black French White BL NK.I1513.0YL	6B.VPWN7.008
	UPPER CASE ASSY LTE SKU W/ BL Keyboard SV05P_A74SBWL SV5P Internal 15 Standard 101KS Black German White BL NK.I1513.0YM	6B.VPWN7.009

Table 6-4. FRU List (Continued)

Category	Description	Acer Part No.
	UPPER CASE ASSY LTE SKU W/ BL Keyboard SV05P_A74SBWL SV5P Internal 15 Standard 101KS Black Swiss/G White BL NK.I1513.0YW	6B.VPWN7.023
	UPPER CASE ASSY LTE SKU W/ BL Keyboard SV05P_A74SBWL SV5P Internal 15 Standard 100KS Black Traditional Chinese White BL NK.I1513.0Y3	6B.VPWN7.024
	UPPER CASE ASSY LTE SKU W/ BL Keyboard SV05P_A74SBWL SV5P Internal 15 Standard 100KS Black Thailand White BL NK.I1513.0Y9	6B.VPWN7.025
	UPPER CASE ASSY LTE SKU W/ BL Keyboard SV05P_A74SBWL SV5P Internal 15 Standard 101KS Black Turkish White BL NK.I1513.0YX	6B.VPWN7.026
	UPPER CASE ASSY LTE SKU W/ BL Keyboard SV05P_A74SBWL SV5P Internal 15 Standard 100KS Black US International White BL NK.I1513.0YA	6B.VPWN7.027
	UPPER CASE ASSY LTE SKU W/ BL Keyboard SV05P_A74SBWL SV5P Internal 15 Standard 101KS Black UK White BL NK.I1513.0YY	6B.VPWN7.028
	UPPER CASE ASSY LTE SKU W/ BL Keyboard SV05P_A74SBWL SV5P Internal 15 Standard 100KS Black US International w/ Bulgaria White BL NK.I1513.0YD	6B.VPWN7.029
	UPPER CASE ASSY LTE SKU W/ BL Keyboard SV05P_A74SBWL SV5P Internal 15 Standard 101KS Black SLO/CRO White BL NK.I1513.0YT	6B.VPWN7.030
	UPPER CASE ASSY LTE SKU W/ BL Keyboard SV05P_A74SBWL SV5P Internal 15 Standard 101KS Black Norwegian White BL NK.I1513.0YR	6B.VPWN7.031
	UPPER CASE ASSY LTE SKU W/ BL Keyboard SV05P_A74SBWL SV5P Internal 15 Standard 100KS Black Ukrainian White BL NK.I1513.0Y7	6B.VPWN7.032
	UPPER CASE ASSY W/ NBL Keyboard SV05T_A74SB SV5T Internal 15 Standard 100KS Black Arabic NK.I1513.0Z0&NK.I151S.09M	6B.VPRN7.001
	UPPER CASE ASSY W/ NBL Keyboard SV05T_A74SB SV5T Internal 15 Standard 101KS Black FR/Arabic NK.I1513.0ZH&NK.I151S.0A4	6B.VPRN7.002

Table 6-4. FRU List (Continued)



Category	Description	Acer Part No.
	UPPER CASE ASSY LTE SKU W/ NBL Keyboard SV05T_A74SB SV5T Internal 15 Standard 101KS Black Swiss/G NK.I1513.0ZU&NK.I151S.0AF	6B.VPSN7.026
	UPPER CASE ASSY LTE SKU W/ NBL Keyboard SV05T_A74SB SV5T Internal 15 Standard 100KS Black Traditional Chinese NK.I1513.0Z1&NK.I151S.09N	6B.VPSN7.027
	UPPER CASE ASSY LTE SKU W/ NBL Keyboard SV05T_A74SB SV5T Internal 15 Standard 100KS Black Thailand NK.I1513.0Z7&NK.I151S.09U	6B.VPSN7.028
	UPPER CASE ASSY LTE SKU W/ NBL Keyboard SV05T_A74SB SV5T Internal 15 Standard 101KS Black Turkish NK.I1513.0ZV&NK.I151S.0AG	6B.VPSN7.029
	UPPER CASE ASSY LTE SKU W/ NBL Keyboard SV05T_A74SB SV5T Internal 15 Standard 100KS Black US International NK.I1513.0Z8&NK.I151S.09V	6B.VPSN7.030
	UPPER CASE ASSY LTE SKU W/ NBL Keyboard SV05T_A74SB SV5T Internal 15 Standard 101KS Black UK NK.I1513.0ZW&NK.I151S.0AH	6B.VPSN7.031
	UPPER CASE ASSY LTE SKU W/ NBL Keyboard SV05T_A74SB SV5T Internal 15 Standard 100KS Black Ukrainian NK.I1513.0Z5&NK.I151S.09S	6B.VPSN7.032
LCD		
	LED LCD Panel CMI 15.6"W FHD None Glare N156HGA-EA3 LF 220nit 10ms 500:1 (eDP, narrow border, 3.2mm max, value)	KL.1560D.035
	LED LCD Panel AUO 15.6"W WXGA None Glare B156XTN08.1 LF 220nit 8ms 400:1 (eDP, 3.2mm Max, narrow border)	KL.15605.048
	LED LCD Panel AUO 15.6"W FHD None Glare B156HAN02.1 H/W:4B LF 250nit 25ms 700:1 (eDP, value IPS, narrow border)	KL.15605.062

Table 6-4. FRU List (Continued)



Category	Description	Acer Part No.
MAINBOARD		
	Mainboard	NB.VPR11.002
MEMORY		
	Memory KINGSTON SO-DIMM DDRIV 2666 4GB ACR26D4S9S1KA-4 LF+HF 512*16 NA-A	KN.4GB07.043
	Memory MICRON SO-DIMM DDRIV 3200 8GB MTA4ATF1G64HZ-3G2E1 LF+HF 1024*16 Z32D	KN.8GB04.048
	Memory HYNIX SO-DIMM DDRIV 3200 8GB HMA81GS6DJR8N-XN LF+HF 1024*8 DA	KN.8GB0G.069
	Memory MICRON SO-DIMM DDRIV 3200 16GB MTA8ATF2G64HZ-3G2E1 LF+HF Z32D	KN.16G04.015
	Memory HYNIX SO-DIMM DDRIV 3200 16GB HMAA2GS6AJR8N-XN LF+HF AL prime	KN.16G0G.035

Table 6-4. FRU List (Continued)















Category	Description	Acer Part No.
POWER CORD		
	POWER CORD 1M 125V EUR+KOR BLACK	27.NE307.015
	POWER CORD 1M 125V US BLACK	27.NE307.003
	POWER CORD 1M 125V JAP BLACK	27.NE307.001
	POWER CORD 1M 125V TAIWAN BLACK	27.NE307.002
	POWER CORD 1M 125V ARG BLACK	27.NE307.004
	POWER CORD 1M 125V AUS BLACK	27.NE307.005
	POWER CORD 1M 125V BRAZIL BLACK	27.NE307.006
	POWER CORD 1M 125V CHINA BLACK	27.NE307.007
	POWER CORD 1M 125V DENMARK BLACK	27.NE307.008
	POWER CORD 1M 125V INDIA BLACK	27.NE307.009
	POWER CORD 1M 125V ISRAEL BLACK	27.NE307.010
	POWER CORD 1M 125V ITL BLACK	27.NE307.011
	POWER CORD 1M 125V S.AFRICA BLACK	27.NE307.012
	POWER CORD 1M 125V SWISS BLACK	27.NE307.013
POWER CORD 1M 125V UK BLACK	27.NE307.014	
MISCELLANEOUS		
	LCD ADHESIVE TAPE	47.VMNN7.001
	RUBBER SI FOR MIC	47.VLLN7.001
	ACETATE TAPE FOR BATTERY(21*21mm)	47.HKKN7.001
	ACETATE TAPE FOR KEYBOARD	47.HNBN7.001
	CONDUCTIVE TAPE	47.VLLN7.002
	BATTERY MYLAR	47.VMLN7.003

Table 6-4. FRU List (Continued)

Category	Description	Acer Part No.
	INS MYLAR FOR LCD PANEL	47.HKCN7.001

Screw List

Table 6-5. Screw List

Category	Description	Acer Part No.
	SCREW M2.5*5.0-I(NI)(NYLOK)IRON	86.VLLN7.001
	SCREW M2.0*3.0-I(BZN)(NYLOK)IRON	86.GDEN7.001
	SCREW M3*0.5+3.5I	86.TDY07.003
	SCREW M2.5*3.0-IZN NYLOK IRONT=0.5	86.VLLN7.002
	SCREW W/WASHER KIT	86.VLLN7.003
	SCREWM2.5*1.8-I(NINYLOK)D5T3.7STEEL	86.GDEN7.002